

Electronics

Computer Display (CD) Module (Plate 1)

Figure 4: Legacy Electronic Computer Display Module

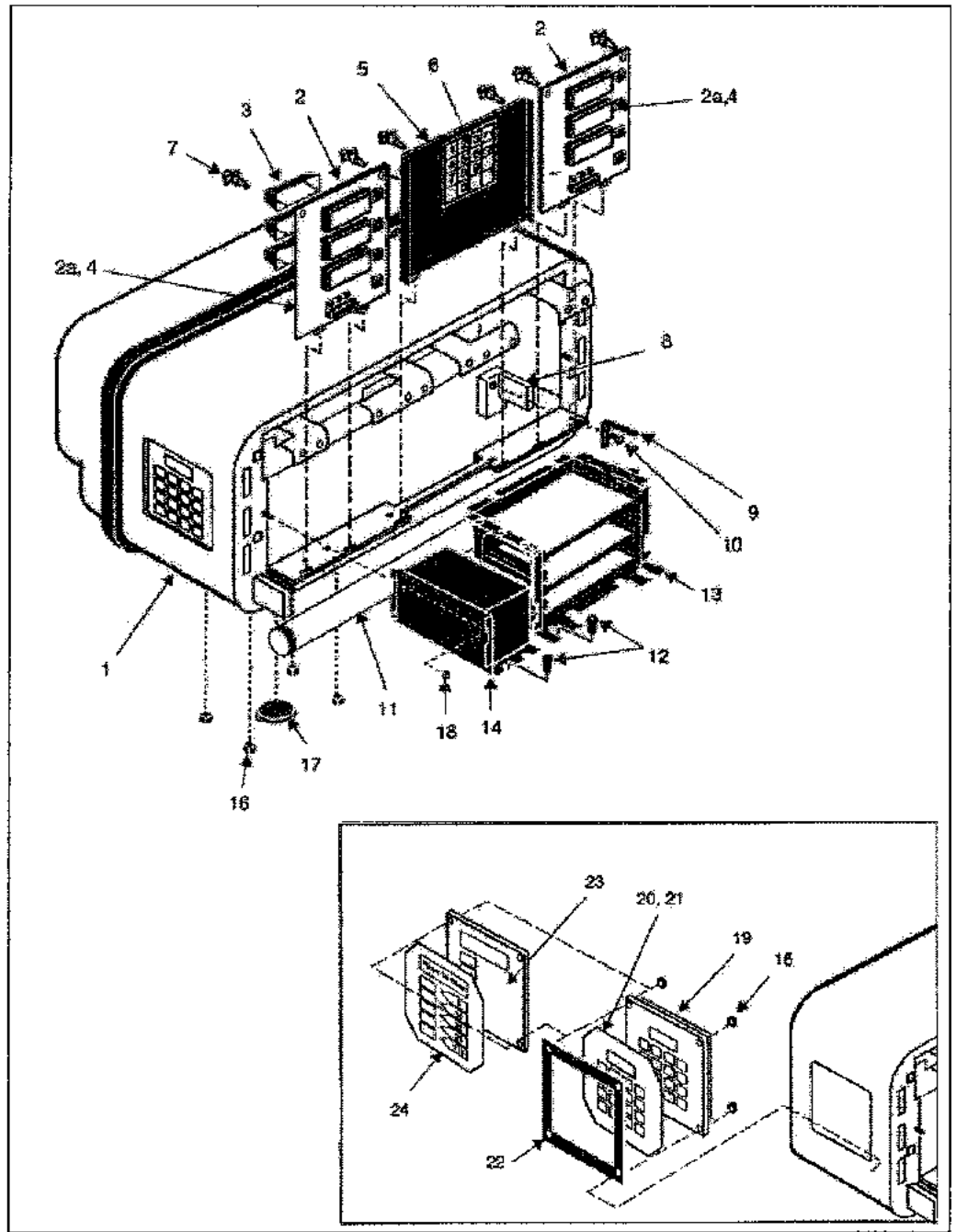

Item #	Part Description	Current Part	Previous Part	Quantity
1	CD Housing ^{1,3}			
	White (opening for customer options) ^{1,3}	T19054-G1	-	1
	Black (no opening) ^{1,3}	T16037-G2	T16037-G2S6	1
	White (no opening) ^{1,3}	T16037-G2	T16037-G2S9	1
2	LCD Main Display Board ^{2,3}	T17701-G1	-	-
2a	Display (0.6", six digit) ^{1,3}	Q12591-01	-	-
3	Reflector and Backlight Assembly (0.6) ³	T17622-G9	T17622-G7	-
4	Display Filters (order three for each display board) ^{1,2,3}			
	Orange ^{1,2,3}	R19211-041	R19211-043	-
	White ^{1,2,3}	R19211-042	-	-
	Green ^{1,2,3}	R19211-044	-	-
5	Operator Panel Assembly ³	T17298-G2	-	2
6	Operator Membrane Switch ³	T17549-G1	-	1
7	Standoff 3/16" ^{2,3}	Q10651-01	-	-
8	Lamp Socket ³	K87111	-	4
9	Leaf Spring ³	N21142	-	4
10	Screw #8-32 X 5/8" ³	Q11270-38	-	4
11	Fluorescent Lamp (modified with ground strips)	N21144-G1	-	2
12	Screw #10-32 X 1/2" ²	K85736-15	-	-
13	Electronic Card Cage ³	See "CD Module Card Cage and Power Supply (Plate 3)" on page 14	-	1
14	Electronic Power Supply ³	See "CD Module Card Cage and Power Supply (Plate 3)" on page 14	-	1
15	Nut #8-32 ^{2,3}	Q12068-04	-	-
16	Square Plastic Plug ³	Q11867-01	-	8
17	Plastic Vent Plug ³	Q10554-13	-	2
18	Nut #10-32 ³	Q12068-04	-	2
19	Customer Programmable Preset Assembly ^{2,3}	R20267-G2	R19295-G2	-
20	Customer Programmable Preset Keypad Overlay ^{1,2,3}	T17885-XX	-	-
21	Customer Programmable Preset Keypad Overlay (generic English graphics) ^{1,2,3}	T17885-01	-	-
22	Gasket, Customer Programmable Preset ^{2,3}	R19509-01	-	-
23	Pump Stop and Five Button Preset Assembly (without LCD display) ^{2,3}	T19326-G1	-	-
24	Pump Stop and Five Button Preset Keypad Overlay ^{1,2,3}	T50005-XX	-	-

1. Order Entry, Customer specific item specify color and graphics when ordering.
 2. Quantity varies with model.
 3. Also used on Highline™ Series models built after 11/01/93.

Bezel (Plate 2)

Figure 5: Legacy Electronic Bezel

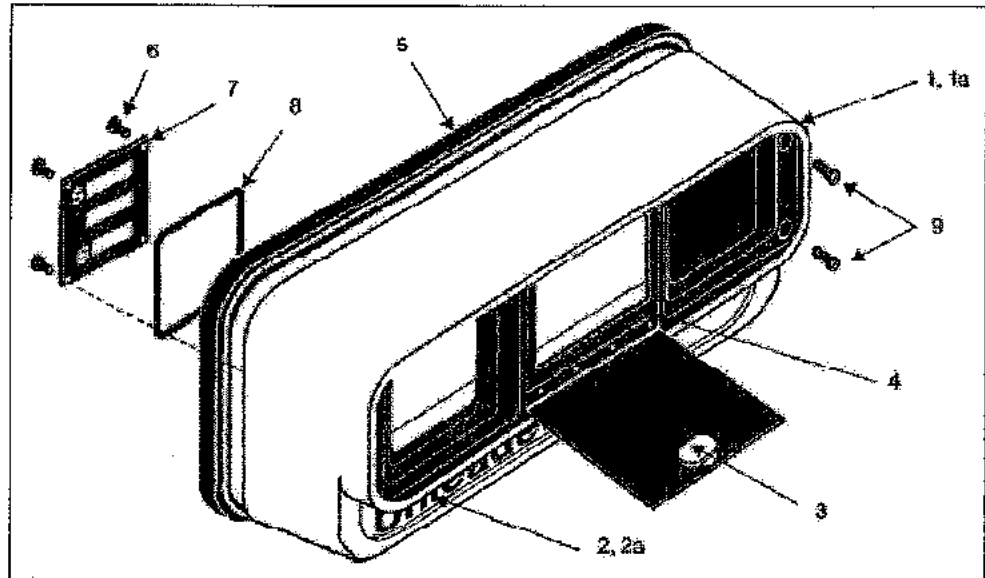

Item #	Part Description	Current Part	Previous Part	Quantity
1	Bezel Assembly for LCD Display (Include 1a - 9) ^{1,2}	T17800-GX	-	1
1a	Bezel only ^{1,2}			
	White ^{1,2}	T12496-09	-	1
	Black ^{1,2}	T12496-G06	T12496-06	1
	Grey ^{1,2}	T12496-XX	-	1
2	Brand Panel Plastic Cover ("L" shaped extruded plastic) ^{1,2}	R15188-01	-	1
2a	Blank Panel ^{1,2}	R15499-XX	-	1
	Blank Brand Panel ²	R15189-01	-	1
3	Access Door and Lock Assembly ^{1,2}	R15185-GX	-	1
	Access Door and Lock Assembly (English with Gilbarco logo) ²	R15185-G1	-	1
	Access Door and Lock Assembly (blank, black without logo) ²	R15185-G13	-	1
3a	Lock and Key (stainless steel) ^{1,2}	Q12928-02	Q10474-01	1
	Lock and Key (black) ²	Q12928-03	Q10474-02	1
3b	Key (Not Shown) ²	K89899-07	-	1
4	Access Door Gasket ²	R15181	-	1
5	Gasket ("U" shaped)	Q10546-02	-	1
6	Screw #6-20 X 1/2" ²	Q11657-26	-	4
7	Face Plate ^{1,2}	RXXXXX-XX	-	1
	Blanking Plate (black, Not Shown) ²	R15175	-	1
	Blanking Plate (grey, Not Shown) ²	R15175-02	-	1
8	Gasket ²	R15596	-	1

Item #	Part Description	Current Part	Previous Part	Quantity
9	Bezel Mounting Bolt 1/4-20 x 3-1/4" ²	Q11098-08	-	2
	Bezel Mounting Bolt 1/4-20 x 1-1/2" (behind door) ²	Q11098-09	-	2

1. Order Entry, Customer specific item - specify color and graphics when ordering.
 2. Also used on Highline Series with LCDs.

CD Module Card Cage and Power Supply (Plate 3)

Figure 6: Legacy Electronic CD Module Card Cage and Power Supply

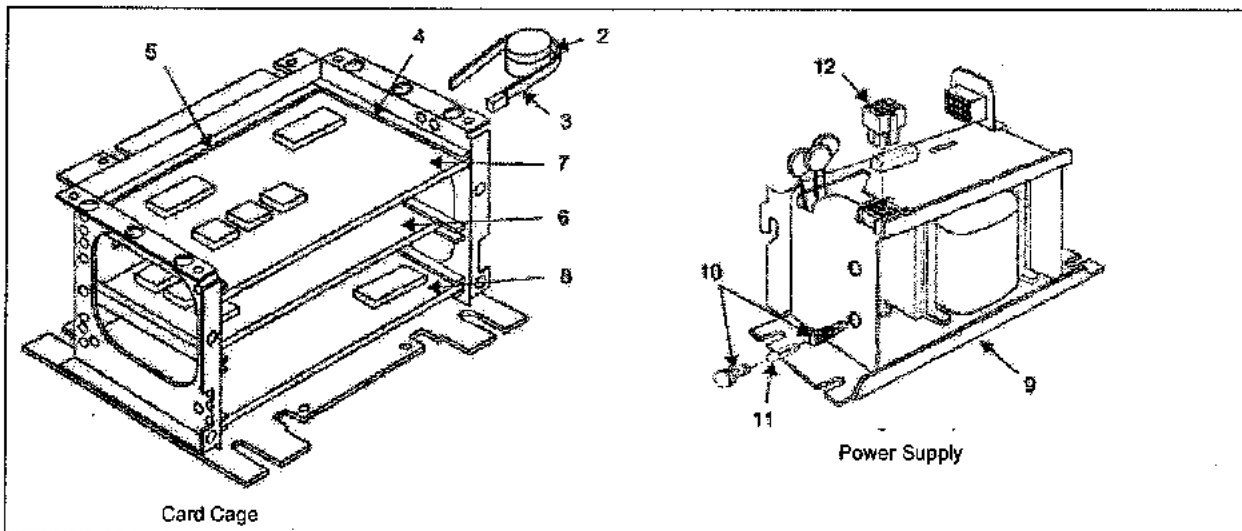

Item #	Part Description	Current Part	Previous Part	Quantity
1	Card Cage (includes 4 - 5) ¹	T17288-G3	-	1
2	Audio Transducer (beeper) ¹	Q11763-01	-	1
3	Cable Tie ¹	Q10176-07	-	1
4	Card Guide 4.5" ¹	Q10233-05	-	6
5	Card Guide 8.5" ¹	Q10233-06	-	3
6	Hydraulics Interface Board ²	T18994-G1	-	1
7	Customer Programmable Preset Board (optional) ¹	T17331-G3	-	1
	Programmable Preset Software Kit ¹	K93376-G1	-	1
8	Pump Controller Board ²	T20092-G1	T18904-G1	1
	Pump Controller Software Kit, Standard flow ²	K93682-G1	-	1
9	Main Power Supply ¹	T16513-G7	-	1
10	Fuse Holder ²	Q11781-01	-	1
11	Fuse, F1 (3 Amp, 250 VAC, Sio-Bio) ²	Q10131-03	-	1

Item #	Part Description	Current Part	Previous Part	Quantity
12	Voltage Select Plug ²			
	115 VAC	N21120-G6	-	1
	220 VAC	N21120-G8	-	1
	230 VAC	N21120-G9	-	1
	240 VAC	N21120-G10	-	1

1. Common to all electronic Gilbarco pumps and dispenser.
2. Also used on Highline Series models built after 11/01/93.

Cables (Plate 4)

Legacy Electronic Cables

Item #	Part Description	Associated Plugs and Jacks	Current Part	Previous Part	Quantity
1	Ground Wire ¹	End 1, End 2	R15634-G58	-	1
2	Ballast ¹	J302B, J802A1/2, J802B1/2	T16595-G1	-	1
3	Power Supply Relays (Pumps only) ¹	P702, GND, K1, K2	R18495-G1	-	1
4	Power Supply Relays (Pumps only) ¹	J702, K1, K2	R18496-G1	-	1
5	Customer Programmable Preset Display ¹	J412/J413, J612/J613	R18944-G1	-	1
6	Controller to Customer Programmable Preset ²	J201, J411	R19936-G1	-	1
7	Main Cable Harness ²	J309, J308, P701, J405, J206, BUZ -C/A, P3, P10, P1A, E1/2, P2, J601, P604, J702, P7, P8	W03261-G1	-	1
8	Main Display Cable ²	J204, J801	T17766-G1	-	1
9	Interface to Controller Ribbon Cable ²	J207/J203, J307/J301	R19951-G1	-	1
10	Interface to Controller Ribbon Cable ²	J205, J305	R19952-G1	-	1
11	Interface to Controller Cable ²	J206, J306	R19939-G1	-	1
12	LCD Backlight Cable ²	P302, J802A1/2/3, J802B1/2/3, J802C1/2/3, J802D1/2/3, WT-1/2	T17766-G3	-	1
13	Pump Stop and Five-Button Preset	J802, J131A/B	T19336-G1	-	-

1. Also used on Highline Series with LCDs.
2. Also used on Highline Series models built after 11/01/93.

Column Area (Plate 5)

Figure 7: Legacy Electronic Column Area

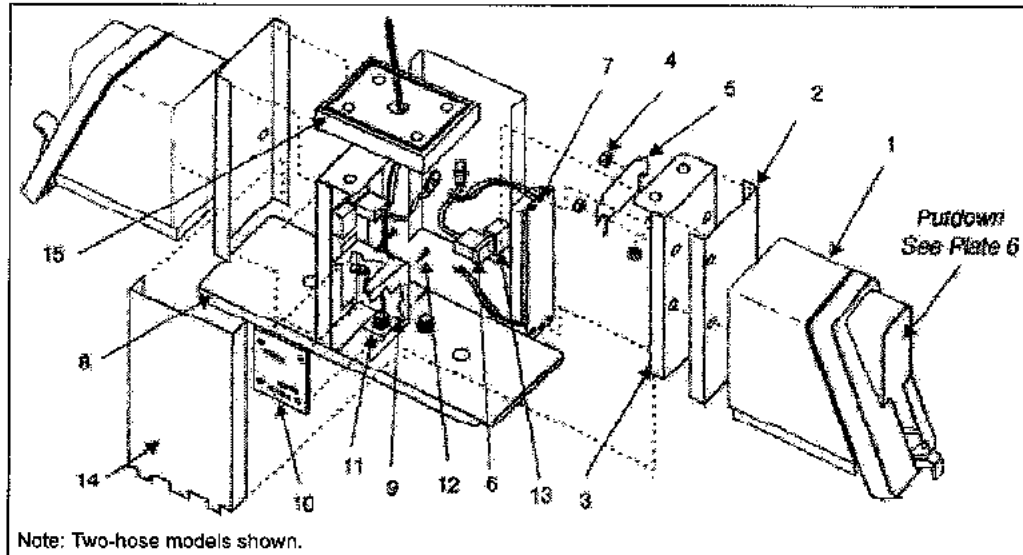

Item #	Part Description	Current Part	Previous Part	Quantity
1	Column Side Sheathing ¹			
	Electromechanical Totalizers, Standard Putdown (island-oriented)	R20074-G5	R20074-G1	1 or 2
	Blank, One-hose Units	T19286-02	-	1
	Electromechanical Totalizers, Rotated Putdown (lane-oriented)	R20074-G5	R20074-G2	1 or 2
	Mechanical Totalizers, Standard Putdown (lane-oriented)	R20074-G9	T19286-04	1 or 2
2	Support Column	W03366-G1	-	2
3	Hex Nut 1/4-20	Q11890-04	-	4
4	Hex Nut 10-32	Q11890-03	-	1
5	Totalizer Bracket ²	R20073	-	-
6	Electromechanical Totalizers ²	Q10939-05	-	-
7	Balst Special ³	M03164B001	K84584 Q10797-01	1
8	Top Sheathing ¹	See "Frame and Sheathing (Plate 12)" on page 26	-	1
9	I.S. Barrier Board Mounting Bracket	T19305	-	1
10	I.S. Barrier Board	T19301-G1	-	1
11	Conduit and Wire Assembly	T19318-G1	-	1
12	Standoffs	Q10651-29	-	4
13	Relay 3-Phase Pumps only	R19406-02	-	-
14	Column Sheathing	R20139-G1	-	2
15	Column Rain Shield	R20119-01	-	1

1. Common to all electronic Gilbarco pumps and dispenser.
 2. Also used on Highline Series models built after 11/01/93.

Putdown Area (Plate 6)

Figure 8: Legacy Electronic Putdown Area

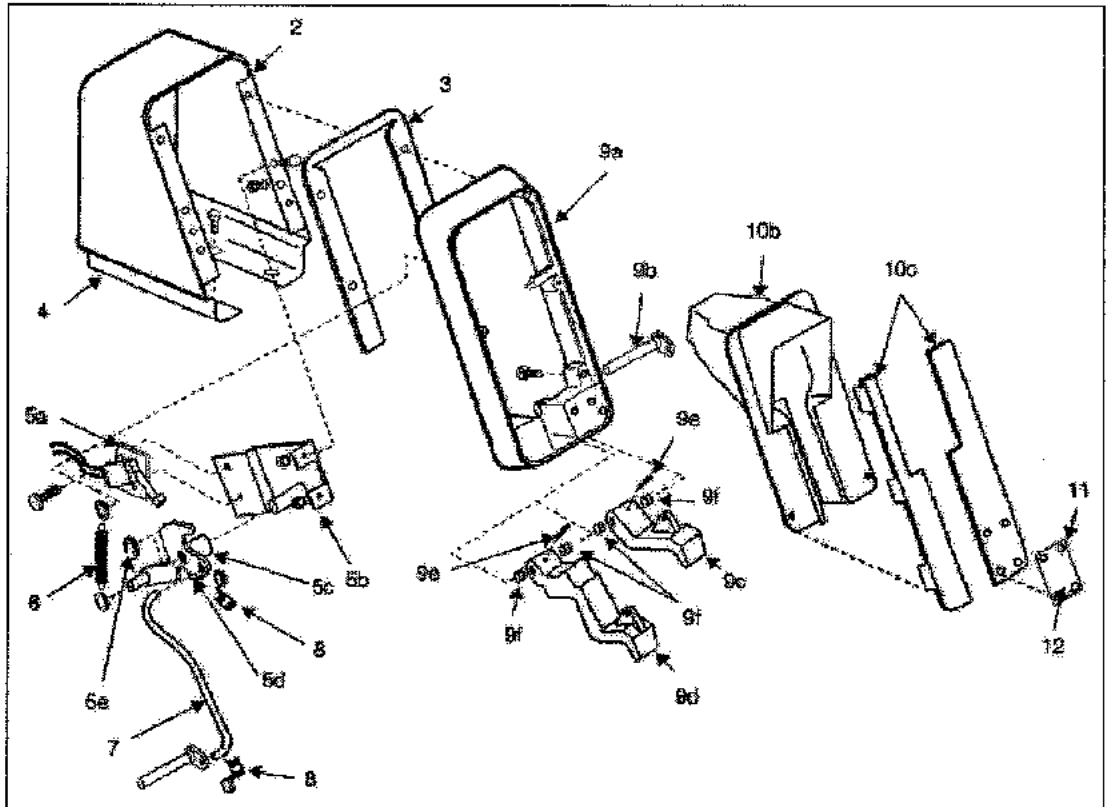

Item #	Part Description	Current Part	Previous Part	Quantity
1	Putdown Module with Standard Nozzle Hooks (include 2, 5 - 9) ¹	W02304-G1	-	-
	Putdown Module with Vapor Recovery Nozzle Hooks (includes 2, 5 - 9) ¹	W02304-G2	-	-
2	Putdown Housing Standard (island-oriented) Nozzle Putdowns ¹			
	White ¹	T14195-11WS	T14195-09WS	1
	Black ¹	T14195-12BS	T14195-10BS	1
2a	Putdown Housing Rotated (island-oriented) Nozzle Putdowns ¹			
	White ¹	T14195-12WS	T14195-10WS	1
	Black ¹	T14195-12BS	T14195-10BS	1
3	Rubber Strip	N20983	-	1
4	Putdown Bottom Plate Rotated (lane-oriented) Nozzle Putdown only	R20157-02	K89984	1
5	Switch and Lever Assembly (includes 5 a - e) ²	K92718-01	-	1
5a	Switch and Bracket ²	K90978	-	1
5b	Bracket ²	N21605-01	-	1
5c	Switch Lever and Pin ²	K89873-04	-	1
5d	Washer ²	K86601-05	-	1

Item #	Part Description	Current Part	Previous Part	Quantity
5e	Retainer Ring ²	K76238-37	-	1
6	Extension Spring/Washers (Standard) ²	K35277	-	1
	Extension Spring/Washers (Vapor Recovery) ²	K35278	-	1
7	Switch Rod ²	K93169	-	1
8	Clevis Clip ²	K77192-22	-	2
9	Wrapper/Nozzle Hook Assembly White (includes 9 a -f) ²	R18428-G2	-	1
	Wrapper/Nozzle Hook Assembly Black Vapor Recovery (includes 9 a -f) ²	R18428-G4	-	1
	Wrapper/Nozzle Hook Assembly Black (includes 9 a -f) ²	R18428-G2	R18428-G6	1
9a	Putdown Wrapper ²	W01589-12	W01589-13	1
9b	Lever and Shaft ²	K93172-G1	-	1
9c	Nozzle Hook (Standard) ²	T19880-11	R14914-14	1
9d	Nozzle Hook (Vapor recovery, leaded) ²	R15090-11	-	1
	Nozzle Hook (Vapor recovery, unleaded) ²	R15749-11	-	1
9e	Groove Pin ²	K76071	-	1
9f	Washer ²	K86601-07	-	2
10a	Nozzle Boot Assembly (includes 10 a - b) ²	T16280-37	-	1
10b	Black Scuff Guard Set ²	R19097-01	-	1
10	Nozzle Boot ²	W01590-13	-	1
11	Instruction Plate for Vapor Boots ²	N21316-01A	-	1
12	Start/Stop Plate ^{1,2}	N22079-XX	-	1
13	Spacer for Rotated Nozzle Putdowns (Not Shown)	T19661-01	T19359	1
<p>1. Order Entry, Customer specific item specify color and graphics when ordering. 2. Also used on Highline, MPD®, and Salesmaker™ Series.</p>				