



Installation Guide For Gilbarco Dispensers

Version 01
23 February, 2021

1414 Radcliffe St. Suite 120
Bristol, PA 19007
Phone: 215.785.6200
Fax: 215.785.0230

COPYRIGHT © 2021 ALLIED ELECTRONICS, INC.

Revision History

Version 01 February 23, 2021
Installation Guide for All Controller Types Established

Contents

1	General Information	4
1.1	Controller Type	4
1.2	Wiring.....	4
1.2.1	Field Wiring	4
1.2.2	Internal Wiring	4
2	Installation Information	6
2.1	Procedures	6
2.1.1	Hardware Installation- Aegis & NeXGen Prime	6
2.1.2	Hardware Installation- NeXGen.....	7
3	Startup	8
3.1	Audible feedback	8
3.2	Shutdown.....	8
3.3	Configuration Diagram.....	9
3.3.1	Allied Controller to Gilbarco.....	9
3.4	Communication Cable and RJ45 Pin Assignments.....	10
3.4.1	POS Communication	10
3.4.2	Allied Controller (CH1) RJ45 adapter to POS (Serial Port, DB25).....	10
3.4.3	Allied Controller (CH1) RJ45 adapter to POS (Serial Port, DB9).....	10
3.4.4	Gilbarco Pump and CRIND Communication.....	10
3.4.5	Gilbarco Security Module Communication.....	12
3.4.6	Allied Controller (CH 4) RJ45 adapter to the GSM	12
3.4.7	OPW OPT	12
3.4.8	Tank Gauge Communication	13
3.4.9	Car Wash Communication.....	16
3.4.10	Fuel Price Sign Communication.....	19
4	Programming	21
4.1	Gilbarco Addressing.....	21
4.1.1	Gilbarco CRIND Jumper Settings.....	21
4.1.2	Gilbarco Distribution Box Jumper Settings	22
4.1.3	Gilbarco Dispenser & CRIND Addressing	23
4.1.4	Gilbarco Blending Dispensers	24
4.1.5	Gilbarco Security Module (GSM) for Debit	27
4.2	Allied Controller Parameters Values and Options.....	27
4.3	Gilbarco Keypads.....	28
4.4	Peripheral Devices.....	52
4.4.1	Tank Gauge Systems	52
4.4.2	Car Wash Controllers	53
4.4.3	Fuel Price Signs	54

1 General Information

1.1 Controller Type

For the purpose of this document Allied Controller refers to NeXGen, NeXGen Prime, and Aegis. Refer to the controller specific User Manual for connection, firmware download, and configuration requirements.

1.2 Wiring

1.2.1 Field Wiring

All field wiring (that is, all wiring connected directly to dispensing devices) should be oil and gas resistant, as required by Paragraph 501-13 of the NEC, and should be sealed in accordance with Article 500 of the NEC.

1.2.2 Internal Wiring

1.2.2.1 Introduction

- a. The purpose of this section is to provide a list of installation practices that we feel are crucial to ensure error-free communications.
- b. All cabling must comply with Local, State, and Federal building codes.
- c. Data connections between the Forecourt Controller are to be made with CAT-5 Cable compliant with TIA/EIA-568-B or better.
- d. Proper cable installation techniques go a long way to preventing data loss.

1.2.2.2 Planning

- a. Pull cables in continuous runs.
- b. Do not splice any communications cables.
- c. Separate all cables from fluorescent lighting ballasts and neon sign transformers by at least 4 feet.
- d. Separate all cables from electrical supply conductors by at least 2 feet.
- e. Provide extra wire for service loops at the termination points but do not leave more than is required.

1.2.2.3 *Execution*

- a. Maintain the natural twist of the cable.
 - i. The cables have four pairs of twisted wires that can very easily lose their ability to reject electromagnetic interference when unraveled.
 - ii. Pay-out cable from spools so that the spool rotates.
- b. Avoid kinking and over-stressing the cable.
 - i. Kinks not only pick up interference, but can cause the jacket to chafe and internal conductors to break.
 - ii. Never exert more than 25 pounds of tension when pulling a communications cable.
- c. Provide a generous bend radius whenever the cable turns a corner.
 - i. Never bend the cable more than 90 degrees.
 - ii. Limit the bend to a 3 inch radius.
 - iii. Use a 1 pound coffee can as a guide.
- d. Support all cabling in both horizontal and vertical planes.
 - i. Unsupported horizontal cable runs, especially above drop ceilings, are problematic.
 - ii. In the event that cable trays are not available, the cabling can be secured with zip-ties, hook clips, J-hooks, or plastic coated staples provided they are spaced no greater than 2' apart.
 - iii. Do not use utility piping or drop ceiling grid-work to secure or support communications cables.
- e. Protect the cable from mechanical damage and install appropriate fire blocking whenever cables pass through floors or walls.
- f. Install carefully all zip-ties ensuring that they do not bite into the cable through excessive force.
- g. Label both ends of all cables.
- h. Use the proper punch down tool and ensure it is set properly.
 - i. Remove as little of the jacket as possible.
 - ii. Untwist the conductors as little as possible.

1.2.2.4 *Testing*

- a. Inspect thoroughly all cables for damage after they are pulled and before they are bundled or otherwise secured.
- b. Perform a continuity test of all pairs.

2 Installation Information

2.1 Procedures

2.1.1 Hardware Installation- Aegis & NeXGen Prime

For the purpose of this section the below images are samples from an Aegis Controller. Installation procedures are the same for Aegis, NeXGen, and NeXGen Prime.

- Attach the two mounting brackets to the Allied controller as shown in figure 2.
- Mount the Allied controller unit to the mounting area using the mounting holes as shown in figure 2. Underwriters Laboratories (UL) requires that the Allied Controller be mounted horizontally to the floor on a shelf perpendicular to the wall. The bottom of the unit should lay flat on the mounting surface. The mounting brackets secure the Allied Controller to the mounting surface.
- Route and connect all communication cables as labeled. Refer to “*Configuration Diagrams*” section (see figure 3).
- Apply AC power to unit by turning the power switch to the ON position (see figure 4).

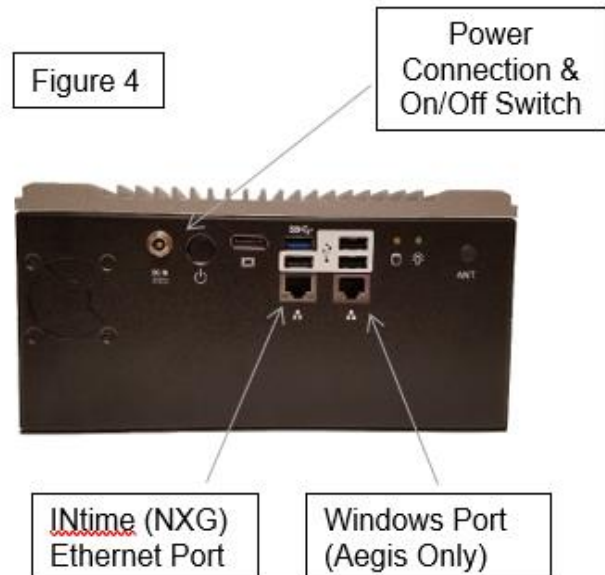
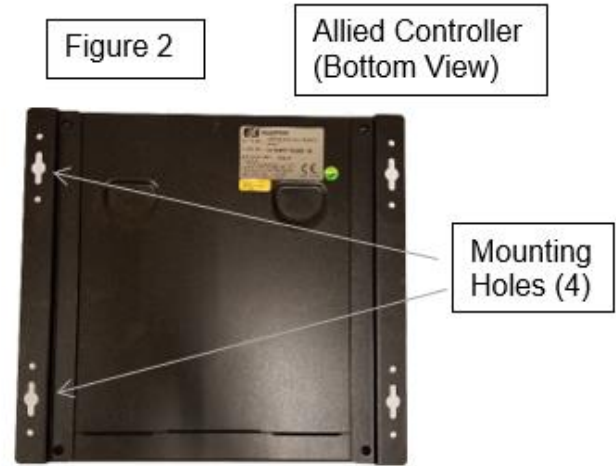

2.1.2 Hardware Installation- NeXGen

For the purpose of this section the below images are samples from a NeXGen Controller. Installation procedures are the same for Aegis, NeXGen, and NeXGen Prime.

- a. Attach the two mounting brackets to the Allied controller as shown in figure 2.
- b. Mount the Allied controller unit to the mounting area using the mounting holes as shown in figure 2. Underwriters Laboratories (UL) requires that the Allied Controller be mounted horizontally to the floor on a shelf perpendicular to the wall. The bottom of the unit should lay flat on the mounting surface. The mounting brackets secure the Allied Controller to the mounting surface.
- c. Route and connect all communication cables as labeled. Refer to “*Configuration Diagrams*” section (see figure 3).
- d. Apply AC power to unit by turning the power switch to the ON position (see figure 4).

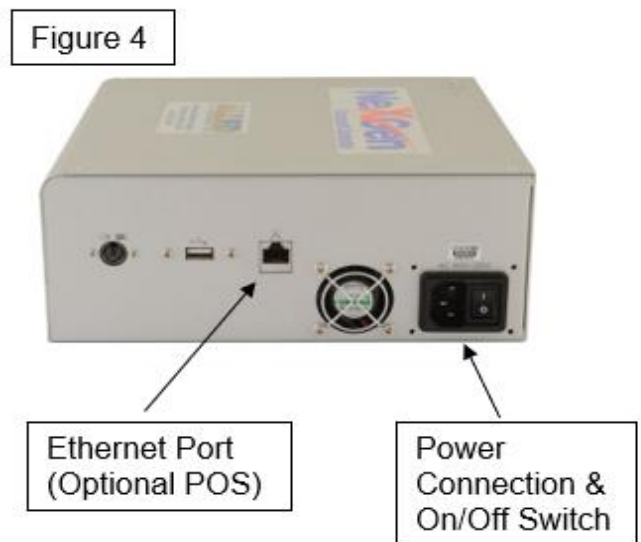
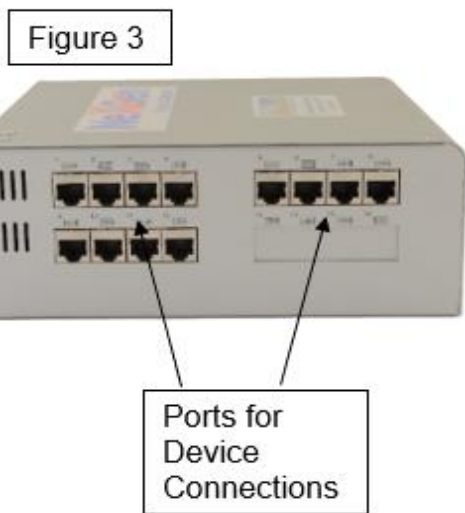
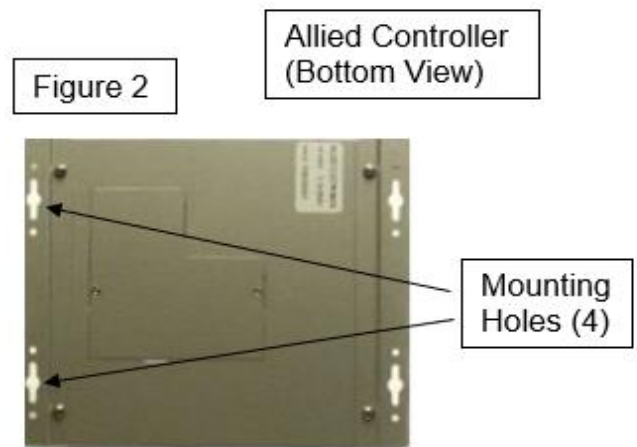

3 *Startup*

Take note that the term ANDI refers to the Allied Network Dispenser Interface – which is the protocol on which the embedded forecourt controller application is based.

After power is applied the INtime RTOS will start up and run the ANDI application. The Allied controller will beep indicating the events listed in section 3.1 were successful.

3.1 *Audible feedback*

- a. BIOS boot: one or several short beeps, shortly after power is applied.
- b. ANDI application startup: two beeps.
- c. ANDI has acquired an IP address: three beeps.

3.2 *Shutdown*

The entire system may be safely shut down by pressing the power key.

If a shutdown is initiated, it is critical to wait for the shutdown to complete before removing the power cord. Shutdown is complete when the power and disk LEDs go out and the fan stops spinning.

3.3 Configuration Diagram

3.3.1 Allied Controller to Gilbarco

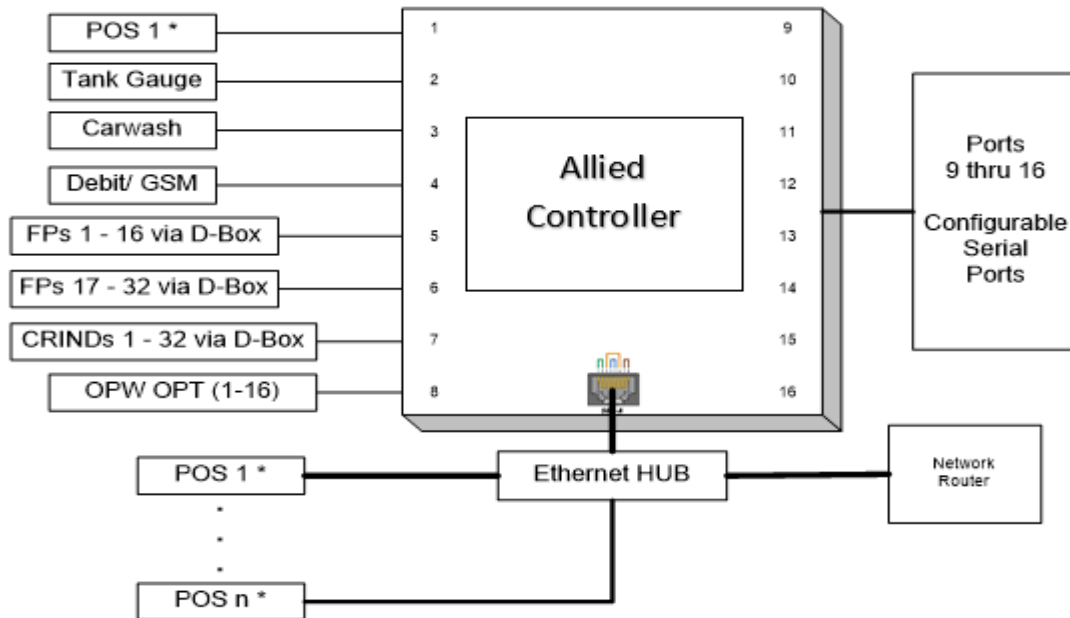

This figure describes the Allied Controller to a Gilbarco system installation with the OPT. For Windows connectivity on Aegis controller, refer to the Aegis User Manual.

* Note: denotes alternative POS connectivity options (RS232 vs. Ethernet)

Communication Ports

CH 1- POS	On board RS-232 port
CH 2- Tank Gauge (Optional)	On board RS-232 port
CH 3- Carwash (Optional)	On board RS-232 port
CH 4- RS232 supported devices	On board RS-232 port (Debit)
CH 5- Dispenser	2-wire20/30/45 mA current loop port
CH 6- Dispenser (Optional)	2-wire20/30/45 mA current loop port
CH 7- CRIND (Optional)	2-wire20/30/45 mA current loop port
CH 8- RS485 Supported devices	4 - channel RS485 port (OPWOPT)
CH 9- Dispenser	2-wire20/30/45 mA current loop port
CH 10- CRIND 2 (Optional)	2-wire20/30/45 mA current loop port
CH 11- Spare	2-wire20/30/45 mA current loop port
CH 12- Spare	4 - channel RS485 port
CH 13- TBD (Optional)	Configurable Serial Port if present
CH 14- TBD (Optional)	Configurable Serial Port if present
CH 15- TBD (Optional)	Configurable Serial Port if present
CH 16- TBD (Optional)	Configurable Serial Port if present
ETHERNET	Network and POS

Note: Contact Technical Support for available options

3.4 Communication Cable and RJ45 Pin Assignments

3.4.1 POS Communication

The Allied controller supports up to 8 POS's. The POS is a PC based computer which runs the Point-Of-Sale software. The serial port on the POS can be either a DB-25 or a DB-9 connector.

3.4.2 Allied Controller (CH1) RJ45 adapter to POS (Serial Port, DB25)

(Part #N9325-ADP)

Allied Controller RJ45 Pins	CAT 5 Cable (T568B Spec.)	RJ45 Modular Jack Pins	POS DB25 Female Pins
DSR 2	Orange	2 (Org)	20 DTR
RXD 3	Wht/Grn	3 (Blk)	2 TXD
RTS 4	Blue	4 (Red)	5 CTS
TXD 5	Wht/Blu	5 (Grn)	3 RXD
CTS 6	Green	6 (Yel)	4 RTS
DTR 7	Wht/Brn	7 (Brn)	6 DSR
GND 8	Brown	8 (Wht)	7 GND

3.4.3 Allied Controller (CH1) RJ45 adapter to POS (Serial Port, DB9)

(Part #N9359-ADP)

Allied Controller RJ45 Pins	CAT 5 Cable (T568B Spec.)	RJ45 Modular Jack Pins	POS DB9 Female Pins
DSR 2	Orange	2 (Org)	4 DTR
RXD 3	Wht/Grn	3 (Blk)	3 TXD
RTS 4	Blue	4 (Red)	8 CTS
TXD 5	Wht/Blu	5 (Grn)	2 RXD
CTS 6	Green	6 (Yel)	7 RTS
DTR 7	Wht/Brn	7 (Brn)	6 DSR
GND 8	Brown	8 (Wht)	5 GND

3.4.4 Gilbarco Pump and CRIND Communication

Up to **16 fueling positions** may be connected to the Allied Controller on each dispenser communications channel (CH5 and CH6). Up To 32 CRINDs may be connected to the Allied Controller on CH7. Each port must have a 2-wire custom cable which terminates in either a 2 pin male CPC (circular plastic connector), a female DB-9 connector or a RJ45 connector.

- Pump Control ⇒ Allied Controller CH5 and CH6 to Gilbarco D-Box
- CRIND Control ⇒ Allied Controller CH7 to Gilbarco Universal D-Box

(1) Circular Plastic Connector

Allied Controller (CH5 or CH6) RJ45 adapter to Gilbarco (CPC)

Allied Controller RJ45 Pins	CAT 5 Cable (T568B Spec.)	RJ45 Modular Jack Pins	Gilbarco Circular Connector Pins
- 6 + 7	----- -----	Wht/Grn Blue	3 (Blk) 4 (Red)
			2 - 1 +

(2) DB-9 Connectors

Allied Controller (CH5, CH6 or CH7) RJ45 adapter to Gilbarco (DB9 Female)
(Part #N9323B-ADP "Pump" / Part #N9323C-ADP "CRIND")

Allied Controller RJ45 Pins	CAT 5 Cable (T568B Spec.)	RJ45 Modular Jack Pins	Gilbarco DB9 Female Pins
- 6 + 7	----- -----	Green Wht/Brn	6 (Yel) 7 (Brn)
			6 - 7 +

(3) RJ-45 Connectors

Allied Controller (CH5, CH6 or CH7) to Gilbarco (RJ45)

Allied Controller RJ45 Pins	CAT 5 Cable (T568B Spec.)	Gilbarco RJ45 Pins
- 6 + 7	----- -----	Green Wht/Brn
		6 - 7 +

3.4.5 Gilbarco Security Module Communication

The Allied Controller uses Channel 4 to interface to the GSM.

The GSM (Gilbarco Security Module) is necessary for CRIND systems that require debit support.

The serial port on the GSM has a **DB-9** connector that has to be connected to Channel 4 of the Allied Controller. The cable pinouts are as follows:

3.4.6 Allied Controller (CH 4) RJ45 adapter to the GSM

(Part #N9330-ADP)

Allied Controller RJ45 Pins	CAT 5 Cable (T568B Spec.)	RJ45 Adapter Pins	GSM DB9 Male Pins
RXD 3	----- Wht/Grn -----	3 (Blk)	2 TXD
RTS 4	----- Blue -----	4 (Red)	9 CTS
TXD 5	----- Wht/Blu -----	5 (Grn)	3 RXD
GND 8	----- Brown -----	8 (Wht)	7 GND

Note: The GSM cable supplied by Gilbarco will **not** work with the Allied Controller. The Allied GSM cable shown above must be used.

3.4.7 OPW OPT

Allied Controller uses Channel 8 to interface to the OPW OPT's. Up to 16 OPT's may be connected. Software Version 18.01A, or newer, must be installed in the OPT and it must be configured as follows:

Baud Rate: 9600, Data Bits: 8, Parity: None, Stop Bits: 1

Allied Controller (CH8) RJ45 adapter to the OPW OPT Junction box

(Part #N9409-ADP)

Allied Controller RJ45 Pins	CAT 5 Cable (T568B Spec.)	RJ45 Modular Jack Pins	OPW OPT "J" box Terminal
RS485 + 1	----- Wht/Org -----	1 (Blue)	1 RS485 +
RS485 - 2	----- Orange -----	2 (Orange)	2 RS485 -

3.4.8 Tank Gauge Communication

The Allied Controller uses Channel 2 to interface to a Veeder-Root or equivalent tank gauge system. Configure the tank gauge communication parameters as follows:

Baud Rate: 9600 Parity: Odd Stop Bits: 1 Data Bits: 7

3.4.8.1 Veeder Root TLS 250/350

On a TLS-250, the communication parameters are set using a rotary switch and DIP switches, (please refer to the TLS 250 manual).

On a TLS-350, the communication parameters are programmed via the TLS keyboard (please refer to the TLS 350/350R manual).

On a TLS-450, the communication parameters are programmed via the touch-screen display (please refer to the TLS 450 manual).

3.4.8.2 Allied Controller (CH 2) RJ45 adapter to the VR TLS 250/350

(Part #N9338-ADP)

Allied Controller RJ45 Pins	CAT 5 Cable (T568B Spec.)	RJ45 Adapter Pins	TLS DB25 Male Pins
RXD 3	----- Wht/Grn -----	3 (Blk)	2 TXD
TXD 5	----- Wht/Blu -----	5 (Grn)	3 RXD
GND 8	----- Brown -----	8 (Wht)	7 GND

3.4.8.3 Veeder Root TLS 450

Allied Controller (CH2) RJ45 adapter to the VR TLS 450

(Part #N9445-ADP)

Allied Controller RJ45 Pins	CAT 5 Cable (T568B Spec.)	RJ45 Modular Jack Pins	TLS DB9 Male Pins
DSR 2	----- Orange -----	2 (Org)	4 DTR
RXD 3	----- Wht/Grn -----	3 (Blk)	3 TXD
RTS 4	----- Blue -----	4 (Red)	8 CTS
TXD 5	----- Wht/Blu -----	5 (Grn)	2 RXD
CTS 6	----- Green -----	6 (Yel)	7 RTS
DTR 7	----- Wht/Brn -----	7 (Brn)	6 DSR
GND 8	----- Brown -----	8 (Wht)	5 GND

3.4.8.4 Red Jacket ST

Allied Controller (CH 2) RJ45 adapter to the Red Jacket "ST"

Allied Controller RJ45 Pins		CAT 5 Cable (T568B Spec.)		RJ45 Adapter Pins	Red Jacket DB9 Female Pins
RXD 3	-----	Wht/Grn	-----	3 (Blk)	3 TXD
TXD 5	-----	Wht/Blu	-----	5 (Grn)	2 RXD
GND 8	-----	Brown	-----	8 (Wht)	5 GND

3.4.8.5 Omntec

Allied Controller (CH 2) RJ45 adapter to the OMNTEC OEL 8000 II

Allied Controller RJ45 Pins		CAT 5 Cable (T568B Spec.)		RJ45 Adapter Pins	OMNTEC DB9 Female Pins
RXD 3	-----	Wht/Grn	-----	3 (Blk)	2 TXD
TXD 5	-----	Wht/Blu	-----	5 (Grn)	3 RXD
GND 8	-----	Brown	-----	8 (Wht)	5 GND

3.4.8.6 OPW EECO

Allied Controller (CH 2) RJ45 adapter to the OPW EECO #1500, 2000, 3000 (Part #N9396-ADP)

Allied Controller RJ45 Pins		CAT 5 Cable (T568B Spec.)		RJ45 Adapter Pins	EECO DB9 Male Pins
RXD 3	-----	Wht/Grn	-----	3 (Blk)	3 TXD
RTS 4	-----	Blue	-----	4 (Red)	8 CTS
TXD 5	-----	Wht/Blu	-----	5 (Grn)	2 RXD
GND 8	-----	Brown	-----	8 (Wht)	5 GND

3.4.8.7 *Incon Tank Sentinel*

Allied Controller (CH 2) RJ45 adapter to the Incon Tank Sentinel
(Part #N9389-ADP)

Allied Controller RJ45 Pins	CAT 5 Cable (T568B Spec.)	RJ45 Adapter Pins	Incon/Comm 1 DB9 Male Pins
RXD 3	----- Wht/Grn -----	3 (Blk)	2 TXD
TXD 5	----- Wht/Blu -----	5 (Grn)	3 RXD
GND 8	----- Brown -----	8 (Wht)	5 GND

3.4.8.8 *TS-550EVO*

Allied Controller (CH2) RJ45 adapter to the TS-550EVO
(Part #N9449-ADP)

Allied Controller RJ45 Pins	CAT 5 Cable (T568B Spec.)	RJ45 Modular Jack Pins	TS DB9 Male Pins
RXD 3	----- Wht/Grn -----	3 (Blk)	2 TXD
RTS 4	----- Blue -----	4 (Red)	8 CTS
TXD 5	----- Wht/Blu -----	5 (Grn)	3 RXD
CTS 6	----- Green -----	6 (Yel)	7 RTS
GND 8	----- Brown -----	8 (Wht)	5 GND
DSR 2	----- Orange -----	2 (Org)	Tie to Brown
DTR 7	----- Wht/Brn -----	7 (Brn)	Tie to Orange

3.4.9 Car Wash Communication

The Allied Controller uses Channel 3 to interface to the car wash controller. Five different car wash controller pinouts are listed in the section below:

- Ryko Code-A-Wash III
- Ryko Code-A-Wash IV (S/N less than 166600)
- Ryko Code-A-Wash IV (S/N 166600 or greater)
- Unitec POS 4000
- Unitec Portal Ti
- Unitec Enterlink
- Unitec Smart terminal
- Kesseltronics Standard
- Kesseltronics Advanced dual bay w/DB9 connection
- Kesseltronics Advanced dual bay w/RJ45 connection

3.4.9.1 Ryko III and Kesseltronics Standard

Allied Controller (CH 3) RJ45 adapter to the Ryko Code A Wash III and Kesseltronics Standard (Part #N9348-ADP)

Allied Controller RJ45 Pins	CAT 5 Cable (T568B Spec.)	RJ45 Adapter Pins	Car Wash DB9 Male Pins
RXD 3	----- Wht/Grn -----	3 (Blk)	9 TXD
TXD 5	----- Wht/Blu -----	5 (Grn)	8 RXD
GND 8	----- Brown -----	8 (Wht)	7 GND
			1 CTS
			4 DCD

3.4.9.2 Ryko IV (S/N less than 166600), Unitec POS 4000, Portal Ti, Exacta & DRB

Allied Controller RJ45 adapter to the Ryko Code A Wash IV, Unitec POS 4000, Portal Ti, Exacta & DRB (Part #N9344-ADP)

Allied Controller RJ45 Pins	CAT 5 Cable (T568B Spec.)	RJ45 Adapter Pins	Car Wash DB9 Female Pins
RXD 3	----- Wht/Grn -----	3 (Blk)	3 TXD
RTS 4	----- Blue -----	4 (Red)	8 CTS
TXD 5	----- Wht/Blu -----	5 (Grn)	2 RXD
DTR 7	----- Wht/Brn -----	7 (Brn)	6 DSR
GND 8	----- Brown -----	8 (Wht)	5 GND

3.4.9.3 Unitec Enterlink, Smart terminal and Ryko IV (S/N 166600 or greater)

Allied Controller (CH 3) RJ45 adapter to the Unitec/Enterlink
(Part #N9352-ADP)

Allied Controller RJ45 Pins	CAT 5 Cable (T568B Spec.)	RJ45 Adapter Pins	Enterlink DB9 Female Pins
RXD 3	----- Wht/Grn -----	3 (Blk)	3 TXD
TXD 5	----- Wht/Blu -----	5 (Grn)	2 RXD
GND 8	----- Brown -----	8 (Wht)	5 GND

3.4.9.4 PDQ

Allied Controller (CH 3) RJ45 adapter to the PDQ
(Part #N9352-ADP)

Allied Controller RJ45 Pins	CAT 5 Cable (T568B Spec.)	RJ45 Adapter Pins	PDQ DB9 Female Pins
RXD 3	----- Wht/Grn -----	3 (Blk)	3 TXD
TXD 5	----- Wht/Blu -----	5 (Grn)	2 RXD
GND 8	----- Brown -----	8 (Wht)	5 GND

3.4.9.5 Kesseltronics Advanced dual bay via the MUX PAP isolator box

**Allied Controller (CH 3) RJ45 adapter to the Kesseltronics
 “Advanced Dual bay” via MUX PAP isolator box /DB9
 (Part #N9352-ADP)**

Allied Controller RJ45 Pins	CAT 5 Cable (T568B Spec.)	RJ45 Adapter Pins	Kesseltronics ADB DB9 Female Pins
RXD 3	----- Wht/Grn -----	3 (Blk)	3 TXD
TXD 5	----- Wht/Blu -----	5 (Grn)	2 RXD
GND 8	----- Brown -----	8 (Wht)	5 GND

**3.4.9.6 Allied Controller (CH 3) RJ45 adapter to the Kesseltronics
 “Advanced Dual bay” via MUX PAP isolator box /RJ45**

Allied Controller RJ45 Pins	CAT 5 Cable (T568B Spec.)	Kesseltronics ADB RJ45 Pins
RXD 3	----- Wht/Grn -----	3 TXD
TXD 5	----- Wht/Blu -----	2 RXD
GND 8	----- Brown -----	4 GND

3.4.10 Fuel Price Sign Communication

The Allied Controller uses an RS232 channel to interface to the Fuel Price Sign.

3.4.10.1 Daktronics Fuel Price Sign (Minimum version required is 5.8)

Allied Controller (CH-RS232) RJ45 adapter to the Daktronics Fuel Price Sign
(Part #N9443-ADP)

Allied Controller RJ45 Pins	CAT 5 Cable (T568B Spec.)	RJ45 Modular Jack Pins	Daktronics DB9 Female Pins
TXD 5	----- Wht/Blu -----	5 (Grn)	2 RXD
RXD 3	----- Wht/Grn -----	3 (Blk)	3 TXD
GND 8	----- Brown -----	8 (Wht)	5 GND
DSR 2	----- Orange -----	2 (Org)]	
DTR 7	----- Wht/Brn -----	7 (Brn)]	
RTS 4	----- Blue -----	4 (Red)]	
CTS 6	----- Green -----	6 (Yel)]	

3.4.10.2 Future Media Displays Fuel Price Sign

Allied Controller (CH-RS232) RJ45 adapter to the FMD Fuel Price Sign
(Part #N9411-ADP)

Allied Controller RJ45 Pins	CAT 5 Cable (T568B Spec.)	RJ45 Adapter Pins	FMD DB9 Male Pins
RXD 3	----- Wht/Grn -----	3 (Blk)	2 TXD
TXD 5	----- Wht/Blu -----	5 (Grn)	3 RXD
GND 8	----- Brown -----	8 (Wht)	5 GND

3.4.10.3 PWM Fuel Price Sign

Allied Controller (CH-RS232) to the PWM Fuel Price Sign

Allied Controller RJ45 Pins	CAT 5 Cable (T568B Spec.)	PWM CAT 5 Cable
DSR 2	Orange	Loop to DTR
DTR 7	Wht/Brn	Loop to DSR
RXD 3	Wht/Grn	5 TXD
RTS 4	Blue	2 CTS
TXD 5	Wht/Blu	4 RXD
CTS 6	Green	3 RTS
GND 8	Brown	1 GND

3.4.10.4 Skyline Fuel Price Sign

Allied Controller (CH-RS232) RJ45 adapter to the Skyline Fuel Price Sign

(Part #N9446-ADP)

Allied Controller RJ45 Pins	CAT 5 Cable (T568B Spec.)	RJ45 Modular Jack Pins	POS DB9 Male Pins
DSR 2	Orange	2 (Org)	6 DTR
RXD 3	Wht/Grn	3 (Blk)	2 TXD
RTS 4	Blue	4 (Red)	7 CTS
TXD 5	Wht/Blu	5 (Grn)	3 RXD
CTS 6	Green	6 (Yel)	8 RTS
DTR 7	Wht/Brn	7 (Brn)	4 DSR
GND 8	Brown	8 (Wht)	5 GND

4 Programming

4.1 Gilbarco Addressing

4.1.1 Gilbarco CRIND Jumper Settings

The following is a list of the jumper settings for the Gilbarco Advantage Series CRINDs.

Jumper	Description	Setting
JP1	Watchdog	Installed
JP14	GEN/MOC	Installed
JP 16	Spare Input	Installed- Sets the baud rate for the CRIND to 4800.
JP13	Side A	When appropriate
JP11	Cold Start	Installed on initial startup. The CRIND will prompt for this to be removed after a complete cold start.
JP4 - JP8	CRIND Address	Set for the appropriate address- one behind the pump address. ex: FP #1, C/R 0, etc.

4.1.2 Gilbarco Distribution Box Jumper Settings

The Allied Controller communicates with the Gilbarco dispensers and CRINDs via two wire communications and uses 45mA current loop ports.

Channel 5 and Channel 6 on the Allied Controller can each communicate with up to sixteen fueling positions. Channel 7 can communicate with up to 32 CRINDs.

The following is a list of the jumper settings for the Gilbarco distribution box for both pump and CRIND communications.

Two wire configuration (45ma)

Jumper	Jumper setting for Boards 1 and 2
JP10	Horizontal
JP12	Horizontal
JP9	Horizontal (Pumps/CRINDs/IPTs)
JP14	Installed

Single and dual board configurations (There are three options:)

- 1 board, 1 input
 - 8 loops for dispensers or CRINDS on board 1
- 2 boards, 1 input
 - 16 loops for dispensers or CRINDs on boards 1 & 2
- 2 boards, 2 inputs
 - 8 loops for dispensers on board 1 and 8 loops for CRINDs on board 2

OR

- 8 loops for dispensers on board 1 and 8 loops for dispensers on board 2.

Option	Jumper setting for Board 1	Jumper setting for Board 2
1	JP11, set to "B"	N/A
1	JP13, set to "B"	N/A
2	JP11, set to "B"	JP11, set to "A"
2	JP13, set to "A"	JP13, set to "B"
3	JP11, set to "B"	JP11, set to "B"
3	JP13, set to "B"	JP13, set to "B"

4.1.3 Gilbarco Dispenser & CRIND Addressing

4.1.3.1 Gilbarco Dispenser & CRIND Addressing

Two Channels (5 and 6) have been designated to communicate with the Gilbarco dispensers. Each channel can accommodate up to 16 fueling positions. The address of the first fueling position on Channel 5 will be set to address “1”, the second to address “2” etc. If Channel 6 is used, the address of the first fueling position connected on these Channels will also be set to address “1”, the second to address “2” etc. See example.

The Allied Controller uses Channel 7 to communicate with the Gilbarco CRINDS. The CRIND device address must be one less than the fueling position number.

The Allied Controller uses channel 8 to communicate with the OPW OPT. Up to 16 OPT’s can be supported and software Version 18.01A, or newer, must be installed. The OPT uses decimal address 32 – 47.

Fueling Position			CRIND Address			OPT	
Fueling Position	Address	Allied Controller Channel	Advantage/E300	Encore 500	Allied Controller Channel	OPT	Allied Controller Channel
1	1	CH-5	0 (no JMP)	32	CH-7	32	CH-8
2	2	CH-5	1	1	CH-7	33	CH-8
3	3	CH-5	2	2	CH-7	34	CH-8
4	4	CH-5	3	3	CH-7	35	CH-8
5	5	CH-5	4	4	CH-7	36	CH-8
6	6	CH-5	5	5	CH-7	37	CH-8
7	7	CH-5	6	6	CH-7	38	CH-8
8	8	CH-5	7	7	CH-7	39	CH-8
9	9	CH-5	8	8	CH-7	40	CH-8
10	10	CH-5	9	9	CH-7	41	CH-8
11	11	CH-5	10	10	CH-7	42	CH-8
12	12	CH-5	11	11	CH-7	43	CH-8
13	13	CH-5	12	12	CH-7	44	CH-8
14	14	CH-5	13	13	CH-7	45	CH-8
15	15	CH-5	14	14	CH-7	46	CH-8
16	16	CH-5	15	15	CH-7	47	CH-8
17	1	CH-6	16	16	CH-7		
18	2	CH-6	17	17	CH-7		
19	3	CH-6	18	18	CH-7		
20	4	CH-6	19	19	CH-7		
21	5	CH-6	20	20	CH-7		
22	6	CH-6	21	21	CH-7		
23	7	CH-6	22	22	CH-7		
24	8	CH-6	23	23	CH-7		
25	9	CH-6	24	24	CH-7		
26	10	CH-6	25	25	CH-7		
27	11	CH-6	26	26	CH-7		
28	12	CH-6	27	27	CH-7		
29	13	CH-6	28	28	CH-7		
30	14	CH-6	29	29	CH-7		
31	15	CH-6	30	30	CH-7		
32	16	CH-6	31	31	CH-7		

4.1.4 Gilbarco Blending Dispensers

Gilbarco Variable Blenders

The Allied Controller interfaces to the following Gilbarco variable blenders:

3+0 4+0 5+0
 3+1 4+1 5+1

A variable blender without diesel, or 3+0, will have position 1, grade 1 on the left on both sides of the pump. Gilbarco products are mapped as positions 1, 3 and 5 (Advantage) and positions 1, 2 and 3 (Advantage with "Optimized" electronics), Low grade, Mid grade and High grade respectively, from left to right when facing each side of the dispenser. A 5+0 will have the products mapped as positions 1, 2, 3, 4 and 5. Low grade, blend grade 1, blend grade 2, blend grade 3 and High grade. The following is an example of a 3+0.

B side	product 3	product 2	product 1	Advantage Adv. w/ optimized & Encore
	position 5 position 3	position 3 position 2	position 1 position 1	
A side	product 1	product 2	product 3	Advantage Adv. w/ optimized & Encore
	position 1 position 1	position 3 position 2	position 5 position 3	

An advantage variable blender with diesel, or 3 + 1, will always have the diesel product for each side mirrored with one another. The diesel will be on the right when facing side A, while diesel will be on the left when facing side B. Gilbarco maps the diesel product as product 6. The remaining grades are mapped the same as the 3 + 0 described above. The pump is shown below:

B Side	product 3	product 2	product 1	product 4	Advantage Adv. w/ optimized & Encore
	position 5 position 3	position 3 position 2	position 1 position 1	position 6 position 6	
A Side	product 1	product 2	product 3	product 4	Advantage Adv. w/ optimized & Encore
	position 1 position 1	position 3 position 2	position 5 position 3	position 6 position 6	

Product to Position Mapping for Gilbarco Variable Blenders

In the Gilbarco system, the product type to product # assignment can be in any order. For the 3+0 and 3+1 variable blenders, the following will be used:

- POS Product #1: Low grade
- POS Product #2: Blended Product
- POS Product #3: High grade
- POS Product #4: Diesel

Model 3 + 0 Variable blender

The table below lists the proper product to position assignment for each blender type which is set via the POS *fueling point configuration* menu.

The *blender type* setting is not used and should be set to zero (0).

Position	Advantage Product	Adv. w/optimized & Encore Product
1	Low grade	Low grade
2	Not assigned	Blended product
3	Blended product	High grade
4	Not assigned	Not assigned
5	High grade	Not assigned
6	Not assigned	Not assigned
7	Not assigned	Not assigned
8	Not assigned	Not assigned

** The low grade and the high grade products may be switched depending on the position of the dispenser and the installation of the product lines.*

Model 3 + 1 Variable Blender

The table below lists the proper product to position assignment for each blender type which is set via the POS **fueling point configuration menu**.

The **blender type** setting is not used and should be set to zero (0).

Position	Advantage Product	Adv. w/optimized & Encore Product
1	Low grade	Low grade
2	Not assigned	Blended product
3	Blended product	High grade
4	Not assigned	Not assigned
5	High grade	Not assigned
6	Diesel	Diesel
7	Not assigned	Not assigned
8	Not assigned	Not assigned

** The low grade and the high grade products may be switched depending on the position of the dispenser and the installation of the product lines.*

Product to Position Mapping Fixed Blenders (Advantage and Optimized)

A Gilbarco fixed blender does not require any special product mapping. The table below lists the proper product to position assignment for this blender type and is programmed via the POS **fueling point configuration menu**.

The **blender type** setting is not used and should be set to zero (0).

Position	Product
1	Low grade
2	Blended product
3	High grade
4	Not assigned
5	Not assigned
6	Not assigned
7	Not assigned
8	Not assigned

** The low grade and the high grade products may be switched depending on the position of the dispenser and the installation of the product lines.*

4.1.5 *Gilbarco Security Module (GSM) for Debit*

The Gilbarco Security Module (GSM) must be ordered from Gilbarco for a specific network application. It should be configured by Gilbarco for the location. There are no switches or jumpers to be set.

4.2 *Allied Controller Parameters Values and Options*

The Allied Controller configuration is provided and sent to the controller by the POS. The POS has to download all required parameters to the Allied Controller. The controller will start polling the dispensers, CRINDs and other peripheral devices only after the POS has downloaded all necessary station configuration data.

Examples Of Parameters Downloaded from POS:

- DPT Configuration
- Fuel Information
- Product Information
- Car Wash Information
- Cash / Credit Limits
- Mode of Service
- Default Price Level
- Sale Stacking
- Number of fueling points
- Network site specific parameters

4.3 Gilbarco Keypads

Please note that the keypads listed below are predefined within the controller. All other keypad types can be configured via the POS to Allied Controller interface using the “DPT Configure Keyboard” command.

Type 1

1	2	3		Pay Outside Credit
4	5	6	Pay Inside Cash	Pay Inside Credit
7	8	9	No	Receipt Yes
Clear	0	Enter	Help	Cancel

Type 2

1	2	3		Pay Outside
4	5	6		Pay Inside
7	8	9	No	Receipt Yes
Clear	0	Enter	Help	Cancel

Type 3

1	2	3	Pay Outside Debit	Pay Outside Credit
4	5	6	Pay Inside Cash	Pay Inside Credit
7	8	9	No	Receipt Yes
Clear	0	Enter	Help	Cancel

Type 4

1	2	3	Pay Outside	
4	5	6		Pay Inside
7	8	9	Yes	Help
Clear	0	Enter	No	Cancel

Type 5 "Info Screen (Virtual Pay Inside only)

Type 6 "Info Screen (Virtual Pay inside Cash & Pay Inside Credit)

Note: Outside Debit and Outside Cash is also supported

Advantage with Monochrome

Soft key Left	--- Pay Here Credit --- Pay Inside (keypad 5) --- Pay Inside Credit (keypad 6) --- Pay Inside Cash (keypad 6)	Soft key Right
Soft key Left		Soft key Right
Soft key Left		Soft key Right
Soft key Left		Soft key Right

Help
Cancel

1	2	3
4	5	6
7	8	9
Clear	0	Enter



Note: This type 5 and 6 keypad configuration will support the location of the Help, Cancel and ADA buttons on either side of the numeric keypad.

Type 5 (Encore)

1	2	3
4	5	6
7	8	9
Clear	0	Enter

Help
Cancel
ADA

Type 7

1	2	3	Pay Here	
4	5	6	Pay Inside	
7	8	9	Yes	No
Clear	0	Enter	Help	Cancel

Type 8

1	2	3	Yes
4	5	6	No
7	8	9	Cancel
Clear	0	Enter	

Type 9

1	2	3	Pay Outside Credit
4	5	6	Pay Outside Debit
7	8	9	Pay Inside Cash
Clear	0	Enter	Cancel

Type A

1	2	3		Pay Outside Credit
4	5	6		Pay Inside
7	8	9	No	Yes
Clear	0	Enter	Help	Cancel

Type B

1	2	3	Pay Outside Debit	Pay Outside Credit
4	5	6		Pay Inside
7	8	9	No	Yes
Clear	0	Enter	Help	Cancel

Type C

1	2	3		Pay Outside Credit
4	5	6	Pay Outside Cash	Pay Inside
7	8	9	No	Yes
Clear	0	Enter	Help	Cancel

Type D

1	2	3	Pay Outside Debit	Pay Outside Credit
4	5	6	Pay Outside Cash	Pay Inside
7	8	9	No	Yes
Clear	0	Enter	Help	Cancel

Type E

1	2	3	Yes
4	5	6	No
7	8	9	Help
Clear	0	Enter	Cancel

Type F

1	2	3	Pay Outside Debit	Pay Outside Credit
4	5	6	Pay Inside Credit	Pay Inside Cash
7	8	9	Cancel	Help
Clear	0	Enter	No	Yes

Type G

1	2	3	Yes	No
4	5	6	Help	Cancel
7	8	9	Debit	
Clear	0	Enter		

Type H

Soft key Left	Customer Specific Prompts	Soft key Right
Soft key Left		Soft key Right
Soft key Left		Soft key Right
Soft key Left		Soft key Right

Cancel
Re-print Receipt

1	2	3
4	5	6
7	8	9
Clear	0	Enter

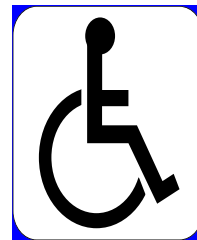

Type I

1	2	3	Outside Credit	
4	5	6	Inside Cash	Inside Credit
7	8	9	No	Yes
Clear	0	Enter	Help	Cancel

Type J

Soft key Left	Customer Specific Prompts	Soft key Right
Soft key Left		Soft key Right
Soft key Left		Soft key Right
Soft key Left		Soft key Right

Cancel
Re-print Receipt
French English

1	2	3
4	5	6
7	8	9
Clear	0	Enter



**Type K
(Soft keys Mirrored 1-4)**

Soft 1 (04)
Soft 2 (05)
Soft 3 (06)
Soft 4 (07)

Soft 5 (08)
Soft 6 (09)
Soft 7 (0A)
Soft 8 (0B)

1	2	3	A	B	C	D	E
4	5	6	F	G	H	I	L
7	8	9	K	L	M	N	O
Clear/No (00)	0	Enter/Yes (01)	P	Q	R	S	T
Cancel (02)	Space (20h/03)	U	V	W	X	Y	Z

Type L

1	2	3	YES	ATM/ DEBIT
4	5	6	NO	
7	8	9	HELP	
Clear	0	Enter	CANCEL	

Type M

1	2	3	Pay Outside Credit	
4	5	6	Pay Outside Debit	
7	8	9	Pay Inside	
Clear/ No	0	Enter/ Yes	HELP	CANCEL

Type N

1	2	3	Outside Debit	
4	5	6	Outside Credit	Pay Inside
7	8	9	No	Yes
Clear	0	Enter	Cancel	

Type O

1	2	3	Pay Inside	
4	5	6	YES	
7	8	9	NO	
Clear	0	Enter	Help	Cancel

Type P

1	2	3	Pay Inside Cash	Pay Inside Credit
4	5	6	Pay Outside Credit	Pay Outside Debit
7	8	9	YES	NO
Clear	0	Enter	HELP	CANCEL

Type Q

(EPP in T-DES - Graphics - Advantage and Encore 300 models)

Notes:

1. Encrypting Pin Pads (EPP's) differ from other in the values that they return.
2. Column 4 does NOT exist on the physical keypad. It is included in this diagram only as a place holder.
3. Pushing the **HELP** key twice, functions as the **ADA** key.

1	2	3		Yes
4	5	6		No
7	8	9		Cancel
Clear	0	Enter		Help

Auxiliary Keypad

Outside Debit
Outside Credit
Pay Inside
ADA

Type R

(EPP in T-DES – Single-line - Advantage and Encore 300 models)

Notes:

1. Encrypting Pin Pads (EPP's) differ from other in the values that they return.
2. Column 4 does NOT exist on the physical keypad. It is included in this diagram only as a place holder.

1	2	3		Yes
4	5	6		No
7	8	9		Cancel
Clear	0	Enter		Help

Auxiliary Keypad

Outside Debit
Outside Credit
Pay Inside

Type S

(EPP in S-DES – Graphics - Advantage and Encore 300 models)

Notes:

1. Encrypting Pin Pads (EPP's) differ from other in the values that they return.
2. Column 4 does NOT exist on the physical keypad. It is included in this diagram only as a place holder.
3. Pushing the **HELP** key twice, functions as the **ADA** key.

1	2	3		Yes
4	5	6		No
7	8	9		Cancel
Clear	0	Enter		Help

Auxiliary Keypad

Outside Debit
Outside Credit
Pay Inside
ADA

Type T

(EPP in S-DES – Single-line - Advantage and Encore 300 models)

Notes:

1. Encrypting Pin Pads (EPP's) differ from other in the values that they return.
2. Column 4 does NOT exist on the physical keypad. It is included in this diagram only as a place holder.

1	2	3		Yes
4	5	6		No
7	8	9		Cancel
Clear	0	Enter		Help

Auxiliary Keypad

Outside Debit
Outside Credit
Pay Inside

Type U
(EPP in T-DES – Graphics - Encore 500 models)

Notes:

1. Encrypting Pin Pads (EPP's) differ from other in the values that they return.
2. Column 4 does NOT exist on the physical keypad. It is included in this diagram only as a place holder.
3. Pushing the **HELP** key twice, functions as the **ADA** key.

1	2	3		Yes
4	5	6		No
7	8	9		Cancel
Clear	0	Enter		Help

Auxiliary Keypad

Outside Debit
Outside Credit
Pay Inside
ADA

Type V
(EPP in S-DES – Graphics - Encore 500 models)

Notes:

1. Encrypting Pin Pads (EPP's) differ from other in the values that they return.
2. Column 4 does NOT exist on the physical keypad. It is included in this diagram only as a place holder.
3. Pushing the **HELP** key twice, functions as the **ADA** key.

1	2	3		Yes
4	5	6		No
7	8	9		Cancel
Clear	0	Enter		Help

Auxiliary Keypad

Outside Debit
Outside Credit
Pay Inside

Type W

(EPP in T-DES – Graphics - Encore 500 S ECIM models)

Notes:

1. Encrypting Pin Pads (EPP's) differ from other in the values that they return.
2. Column 4 does NOT exist on the physical keypad. It is included in this diagram only as a place holder.
3. Pushing the **HELP** key twice, functions as the **ADA** key.

1	2	3		Yes
4	5	6		No
7	8	9		Cancel
Clear	0	Enter		Help

Auxiliary Keypad

Outside Debit
Outside Credit
Pay Inside
ADA

Type X

(EPP in S-DES – Graphics - Encore 500 S ECIM models)

Notes:

1. Encrypting Pin Pads (EPP's) differ from other in the values that they return.
2. Column 4 does NOT exist on the physical keypad. It is included in this diagram only as a place holder.
3. Pushing the **HELP** key twice, functions as the **ADA** key.

1	2	3		Yes
4	5	6		No
7	8	9		Cancel
Clear	0	Enter		Help

Auxiliary Keypad

Outside Debit
Outside Credit
Pay Inside
ADA

Type Y
(EMV in S-DES – Compatible mode)

Notes:

1. EMV returns different values for CANCEL and ENTER when in buffered mode. The keys in this table reflect the "normal" returns. CRIND code is responsible for handling the special case when in buffered

1	2	3	Cancel
4	5	6	Clear
7	8	9	Enter (ok)
Shift	0	Help	

Auxiliary Keypad

French

Type Z

(EPP in T-DES – Graphics – Advantage and Encore 300 models w/o Auxiliary keys)

Notes:

1. Encrypting Pin Pads (EPP's) differ from other in the values that they return.
2. Column 4 does NOT exist on the physical keypad. It is included in this diagram only as a place holder.
3. Pushing the **HELP** key twice, functions as the **ADA** key.

1	2	3		Yes
4	5	6		No
7	8	9		Cancel
Clear	0	Enter		Help

ADA

Type a

(EPP in S-DES – Graphics – Advantage and Encore 300 models w/o Auxiliary keys)

Notes:

1. Encrypting Pin Pads (EPP's) differ from other in the values that they return.
2. Column 4 does NOT exist on the physical keypad. It is included in this diagram only as a place holder.
3. Pushing the **HELP** key twice, functions as the **ADA** key.

1	2	3		Yes
4	5	6		No
7	8	9		Cancel
Clear	0	Enter		Help

ADA

Type b

(CK Generic EPP w/o Auxiliary keys)

Notes:

1. Encrypting Pin Pads (EPP's) differ from other in the values that they return.

1	2	3		
4	5	6		
7	8	9	No	Yes
Clear	0	Enter	Help	Cancel

ADA

Type c
(CK Shell branded EPP with Auxiliary keys)

Notes:

1. Encrypting Pin Pads (EPP's) differ from other in the values that they return.

1	2	3	Debit Outside	
4	5	6		
7	8	9	No	Yes
Clear	0	Enter	Help	Cancel

ADA

Type d
(CK ExxonMobil branded EPP with Auxiliary keys)

Notes:

1. Encrypting Pin Pads (EPP's) differ from other in the values that they return.

1	2	3	Debit Outside	Credit Outside
4	5	6	Cash Inside	Credit Inside
7	8	9	No	Yes
Clear	0	Enter	Help	Cancel

ADA

**Type e
(S-DES UPT)**

1	2	3	Debit Outside	Credit Outside
4	5	6	Cash Inside	Credit Inside
7	8	9	No	Yes
Clear	0	Enter	Help	Cancel

ADA
ADA
ADA
ADA

**Type f
(T-DES UPT)**

1	2	3	Debit Outside	Credit Outside
4	5	6	Cash Inside	Credit Inside
7	8	9	No	Yes
Clear	0	Enter	Help	Cancel

ADA
ADA
ADA
ADA

Type g
Soft keys Reversed (5-8::1-4)

Soft 1 (04)
Soft 2 (05)
Soft 3 (06)
Soft 4 (07)

Soft 5 (08)
Soft 6 (09)
Soft 7 (0A)
Soft 8 (0B)

1	2	3	A	B	C	D	E
4	5	6	F	G	H	I	L
7	8	9	K	L	M	N	O
Clear/No (00)	0	Enter/Yes (01)	P	Q	R	S	T
Cancel (02)	Space (20h/03)	U	V	W	X	Y	Z

**Type h
(AN Support Req)**

Soft 1 (04)
Soft 2 (05)
Soft 3 (06)
Soft 4 (07)

Soft 5 (08)
Soft 6 (09)
Soft 7 (0A)
Soft 8 (0B)

1	2	3	A	B	C	D	E
4	5	6	F	G	H	I	L
7	8	9	K	L	M	N	O
Clear/No (00)	0	Enter/Yes (01)	P	Q	R	S	T
Cancel (02)	Space (20h/03)	U	V	W	X	Y	Z

Type i

1	2	3	Payer À L'Intérieur Pay Inside	
4	5	6	Oui Yes	Non No
7	8	9	Français / English	
Corriger Clear	0	Entrer Enter	Aide Help	Annuler Cancel

**Type j
(T-DES UPT)**

1	2	3		Yes
4	5	6		No
7	8	9		Cancel
Clear	0	Enter		Help

ADA
ADA
ADA
ADA

**Type k
(T-DES UPT)**

1	2	3		Yes
4	5	6		No
7	8	9		Cancel
Clear	0	Enter		Help

ADA
ADA
ADA
ADA

4.4 Peripheral Devices

4.4.1 Tank Gauge Systems

The Allied Controller uses Channel 2 to interface to either the Veeder-Root tank gauge system or compatible system. The controller is connected to the serial board on a device and it may be connected to the DIM board on a TLS 350R.

When the controller is connected to the DIM board on a TLS 350R, it will send real-time fuel transaction data (i.e. sale started, sale complete, volume dispensed, meter reading etc.). This is accomplished by implementing the Veeder-Root Dispenser Interface Protocol (a proprietary interface defined by Veeder-Root for the TLS 350R). This will allow the TLS to utilize the AccuChart Automatic Tank Calibration feature for underground storage tank reconciliation.

Configure the TLS-250/350/350R or the Red Jacket communication parameters as follows:

Baud Rate - 9600, Parity - Odd, Stop Bits - 1, Data Bits - 7

Notes:

On a TLS-250, the communication parameters are set using a rotary switch and some DIP switches, (please refer to the TLS 250 manual).

On a TLS-350/350R, the communication parameters are programmed via the TLS keyboard (please refer to the TLS 350/350R manual).

No additional controller configuration is needed. The Allied Controller will automatically check if it is connected to a DIM card. Otherwise, the controller will not send any Dispenser Interface commands to the TLS. Communicating with other devices requires POS programming.

4.4.2 Car Wash Controllers

The following requirements must be met in order for the Car Wash controllers to communicate to the Allied Controller.

Car Wash controller	Software Version
Ryko Code A Wash III	"8B" or newer
Ryko Code A Wash IV	"V" (1)
Unitec POS 4000	"6.50" or newer (2)
Unitec Portal Ti	Any version
Unitec/Enterlink	Any version
Unitec Smart terminal	
Kesseltronics	Any version
PDQ	Any version

Notes:

1. The Ryko Code A Wash IV should communicate to the Allied Controller using any version of software. However, Ryko recommends that the controller be upgraded to the latest version.
2. The Unitec software must be able to support External POS 1, 2 or 3. This information may be found either on the PROM label which is located inside the controller, or via the configuration report printed from the controller. There will be a line on the report indicating the "External POS" type.
 - a. The Unitec controller must be programmed to use the Ryko protocol. See section 6.2.10 in the External POS Menu of the Unitec manual. Set POS offset to "0", Down. Set External POS type to "2". Set baud rate to 9600.
 - b. If the Unitec hardware version is 6.1, a (SA1606) 9 pin adapter (which can be ordered from Unitec, if required) must be used to connect the serial port to the communication cable. If the hardware version is 6.2 or higher, the communication cable must be connected directly to the 9 pin serial port.
 - c. To distinguish the difference between 6.1 type hardware and 6.2 type hardware, look at the label attached to the base of the unit. If the Model field has "POS4000" then it unit is equipped with 6.1 hardware. If it has "POS4000/2" (or /3 etc.) then it is equipped with 6.2 or higher hardware. The 6.2 and higher cable pinouts are standard for a 9-pin DTE serial port, which is not the case for 6.1 units.
3. The Ryko Code A Wash II will not work with the Allied Controller. It can be upgraded to a Code A Wash III.

4.4.3 Fuel Price Signs

The Allied Controller supports the Future Media Display (FMD) protocol. The use of the FMD electronic price sign is configurable and can be mapped to an available serial RS232 port via the Allied Diagnostic (ANDI_DGS) utility.

The following signs communicate with the Allied Controller via the use of the ANDI protocol message set. These devices physically connect to an available POS RS232 for communications.

- PWM
- Daktronics
- Skyline
- Sunshine

The controllers noted above may have specific software version requirements for the support of the ANDI protocol interface. Please contact the respective manufacturer for specific details.

Other sign integrations are currently under development. Please contact Allied Electronics, Inc. for up to date details regarding other possible signs that have integrated to the controller.