

15 – Tubing Section

Vapor System Return Lines (Self-contained)

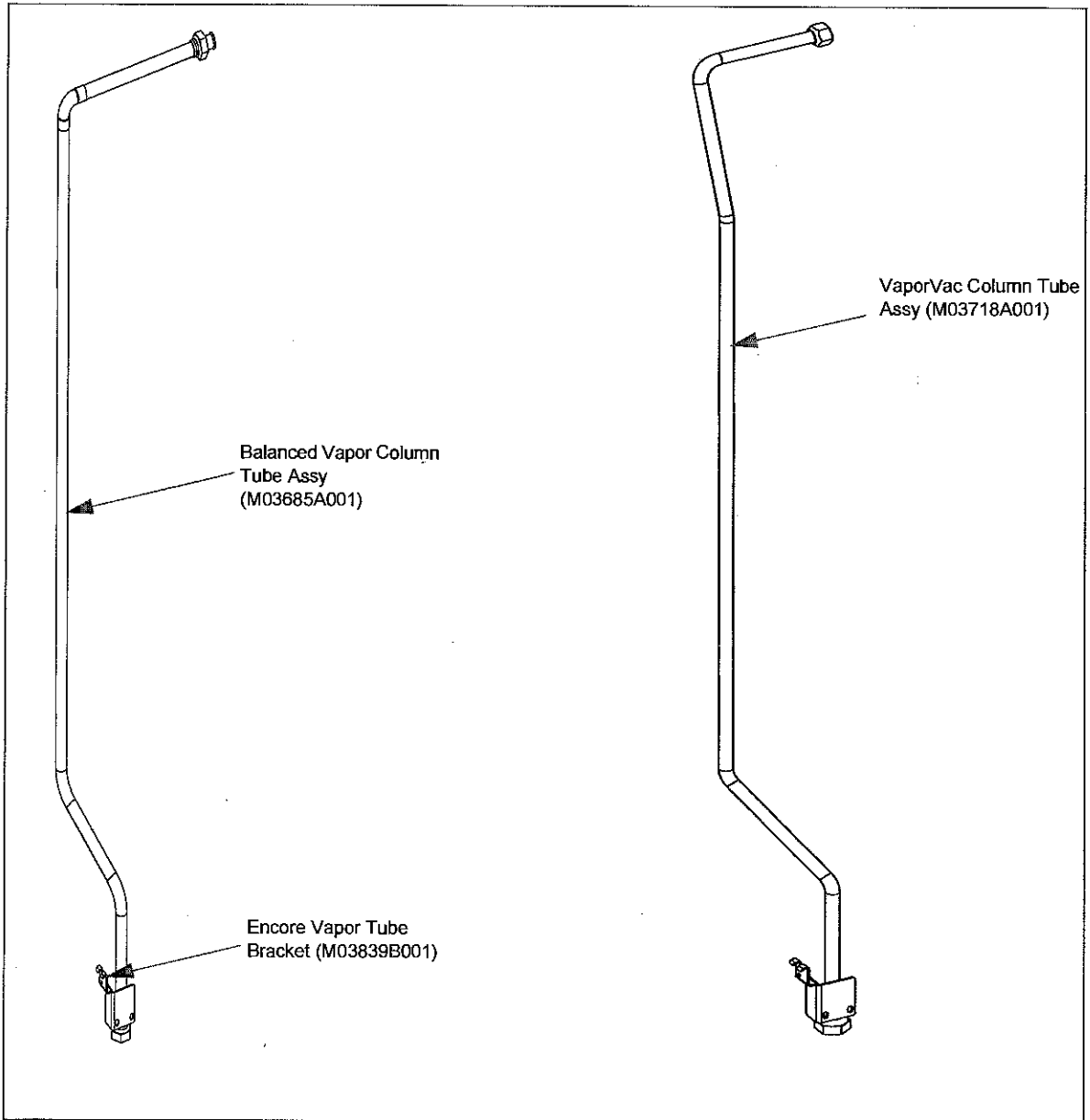

Balance and Vapor Ready

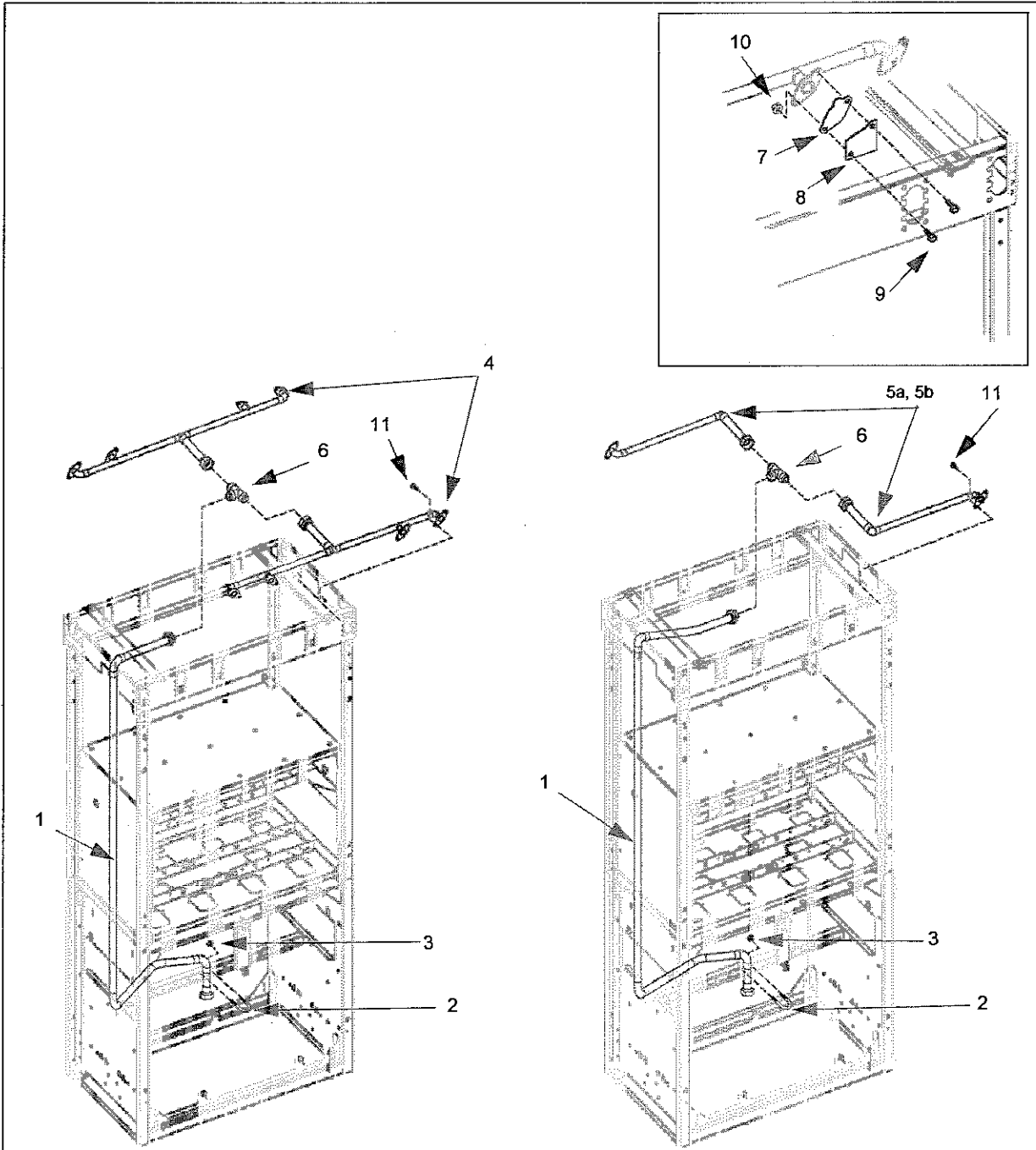

Item #	Description	Current Part	Previous Part	Quantity
1	Vapor Recovery Line	M01150A001	-	1
	Vapor Recovery Line (Self-contained Units Only) (Not Shown) Prior to 04/06	M01150A002	-	1

Item #	Description	Current Part	Previous Part	Quantity
2	• U-bolt, Metric M8	M00703B001	-	1 per Outlet
3	• Nut, Metric M8 (See Note 1)	-	-	2 per Outlet
4	Upper Vapor Recovery Balanced	M01237A001	-	2 per Outlet
5a	Vapor Tube, Single Hose Balanced- Discharge, Right	M01446A001	-	1 per Outlet
5b	Vapor Tube, Single Hose Balanced- Discharge, Left	M01446A002	-	1 per Outlet
6	Tee, 1" X 1" X 1"	M01161B002	M01161B001	1 per Outlet
7	Vapor Plug Plate, Balanced	M01329B001	-	2 per Outlet
8	Vapor Plug Gasket	M00620B001	-	2 per Outlet
9	• Screw, (Button Head) M8 X 20 (See Note 1)	M01257B010	-	2 per Outlet
10	• Nut, Metric M8 Serrated (See Note 1)	M00414B003	-	2 per Outlet
11	Screw, M8 X 20 (See Notes 1 and 2)	-	-	2 per Outlet

Notes:

1. Use metric hardware kit K96620-01 (includes screws, nuts, bolts) to replace fasteners.
2. Screws are used to attach tube to Hose Outlet casting. Hose Outlet casting is not shown (refer to "Hydraulics Section" on page 11-1).

Discharge Tubing

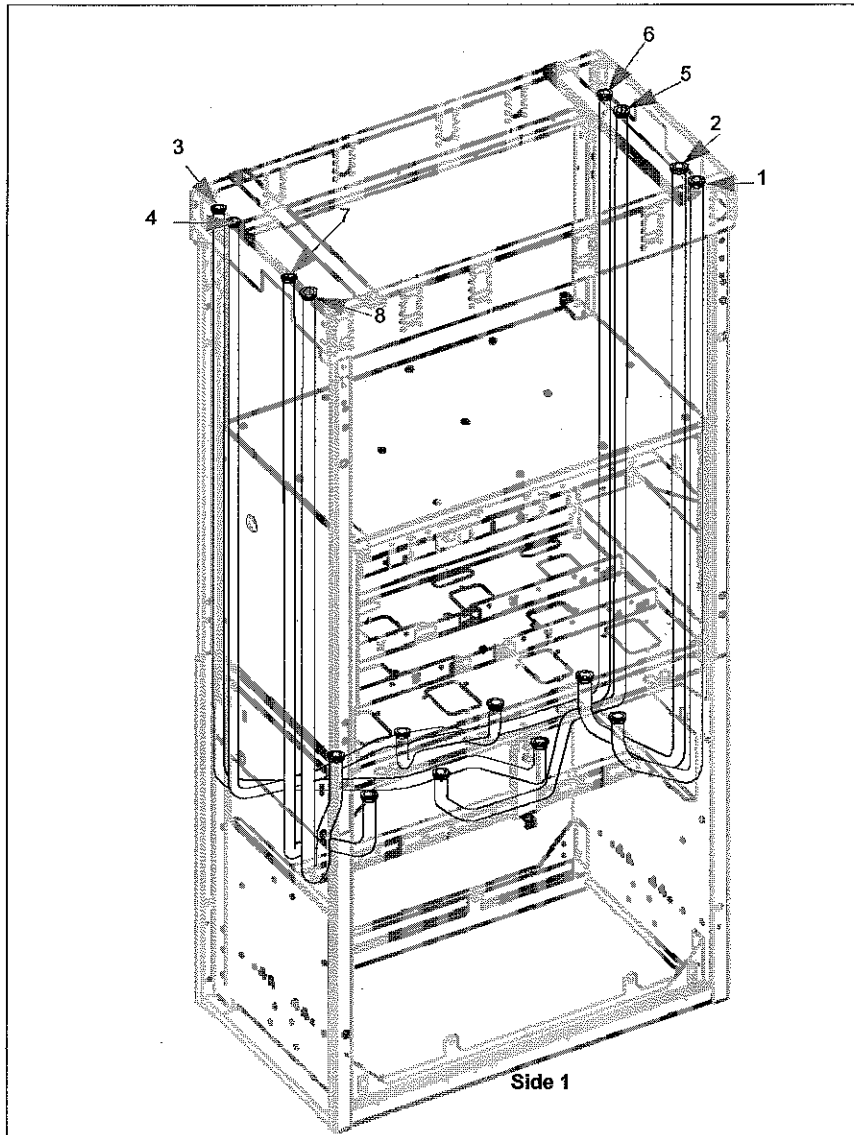

Unit	Item #	Current Part	Previous Part
All Encore 300 and 500 Dispensers, and Self-contained (Pumping Units Built Prior to April 2006)	1	M00393A001	-
Flexible Fuels		M07803A001	-
All Encore 300 and 500 Dispensers, and Self-contained (Pumping Units Built Prior to April 2006)	2	M00394A002	M00394A001
Flexible Fuels		M07804A001	-
All Encore 300 and 500 Dispensers, and Self-contained (Pumping Units Built Prior to April 2006)	3	M00395A001	-
Flexible Fuels		M07805A001	-
All Encore 300 and 500 Dispensers, and Self-contained (Pumping Units Built Prior to April 2006)	4	M00396A002	M00396A001
Flexible Fuels		M07806A001	-
All Encore 300 and 500 Dispensers, and Self-contained (Pumping Units Built Prior to April 2006)	5	M00397A002	M00397A001
Flexible Fuels		M07807A001	-
All Encore 300 and 500 Dispensers, and Self-contained (Pumping Units Built Prior to April 2006)	6	M00398A001	M00398A002
Flexible Fuels		M07808A001	-
All Encore 300 and 500 Dispensers, and Self-contained (Pumping Units Built Prior to April 2006)	7	M00816A003	M00816A001
Flexible Fuels		M07809A001	-
All Encore 300 and 500 Dispensers, and Self-contained (Pumping Units Built Prior to April 2006)	8	M00817A001	-
Flexible Fuels		M07810A001	-

Discharge Tubing (Dispensers)

Item #	Description	Current Part (Galvanized)	Previous Part (Copper)
1	Tube, Meter Discharge 11	M08433A001	M00393A001
2	Tube, Meter Discharge 21	M08435A001	M00395A001
3	Tube, Meter Discharge 14	M08440A001	M00817A001
4	Tube, Meter Discharge 24	M08438A001	M00398A001
5	Tube, Meter Discharge 12	M08434A001	M00394A002
6	Tube, Meter Discharge 22	M08436A001	M00396A002
7	Tube, Meter Discharge 13	M08439A001	M00816A003
8	Tube, Meter Discharge 23	M08437A001	M00397A002

Notes: 1) The tubes mentioned above are Discharge Tubes in the dispenser.

2) Galvanized tubing is not currently approved for use with Ecometer and Ultra-Hi units; for these units, use the previous part (copper).

3) For Ultra-Hi units and units without Ecometers, copper tubing can be replaced with galvanized tubing. Do not use copper tubing for Flexible Fuel dispensers.

Discharge Tubing (Pumps) Post April 2006

Item #	Description	Current Part (Galvanized)	Previous Part (Copper)
4	Tube, Meters Discharge 11	M09021A001	M06169A001
5	Tube, Meters Discharge 21	M09025A001	M06173A001
6	Tube, Meters Discharge 12	M09022A001	M06170A001
7	Tube, Meters Discharge 22	M09026A001	M06174A001
8	Tube, Meters Discharge 13	M09023A001	M06171A001
9	Tube, Meters Discharge 23	M09027A001	M06175A001
10	Tube, Meters Discharge 14	M09024A001	M06172A001
11	Tube, Meters Discharge 24	M09028A001	M06176A001

Notes: 1) The tubes mentioned above are Discharge Tubes in the dispenser.

2) Galvanized tubing is not currently approved for use with Ecometer and Ultra-Hi units; for these units, use the previous part (copper).

3) For Ultra-Hi units and units without Ecometers, copper tubing can be replaced with galvanized tubing. Do not use copper tubing for Flexible Fuel dispensers.

Discharge Tubing (Self-contained Units)

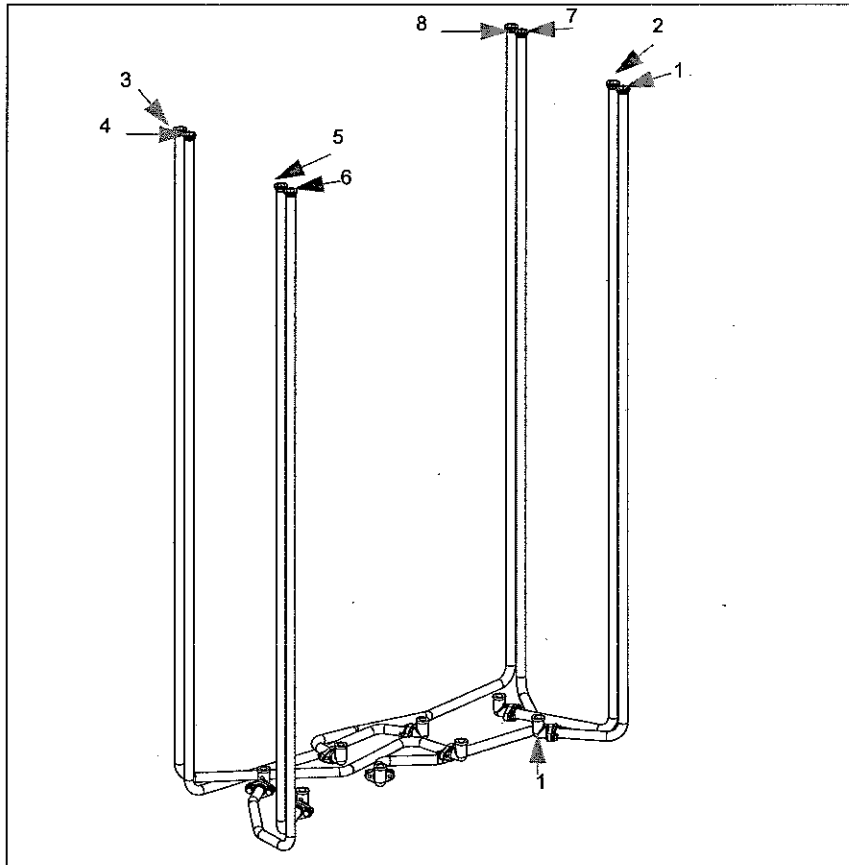

Unit	Item #	Description	Part Number
Encore Self-contained Pumping Units (Built after April 2006 Only)	1	Tube, Meter Discharge 11	M06169A001
	2	Tube, Meter Discharge 12	M06170A001
	3	Tube, Meter Discharge 21	M06173A001
	4	Tube, Meter Discharge 22	M06174A001
	5	Tube, Meter Discharge 13	M06171A001
	6	Tube, Meter Discharge 14	M06172A001
	7	Tube, Meter Discharge 23	M06175A001
	8	Tube, Meter Discharge 24	M06176A001
	9	Motor Discharge Casting	M05398B011

Encore 550 - SMART Meter

Discharge Tubing (Upper Offset)

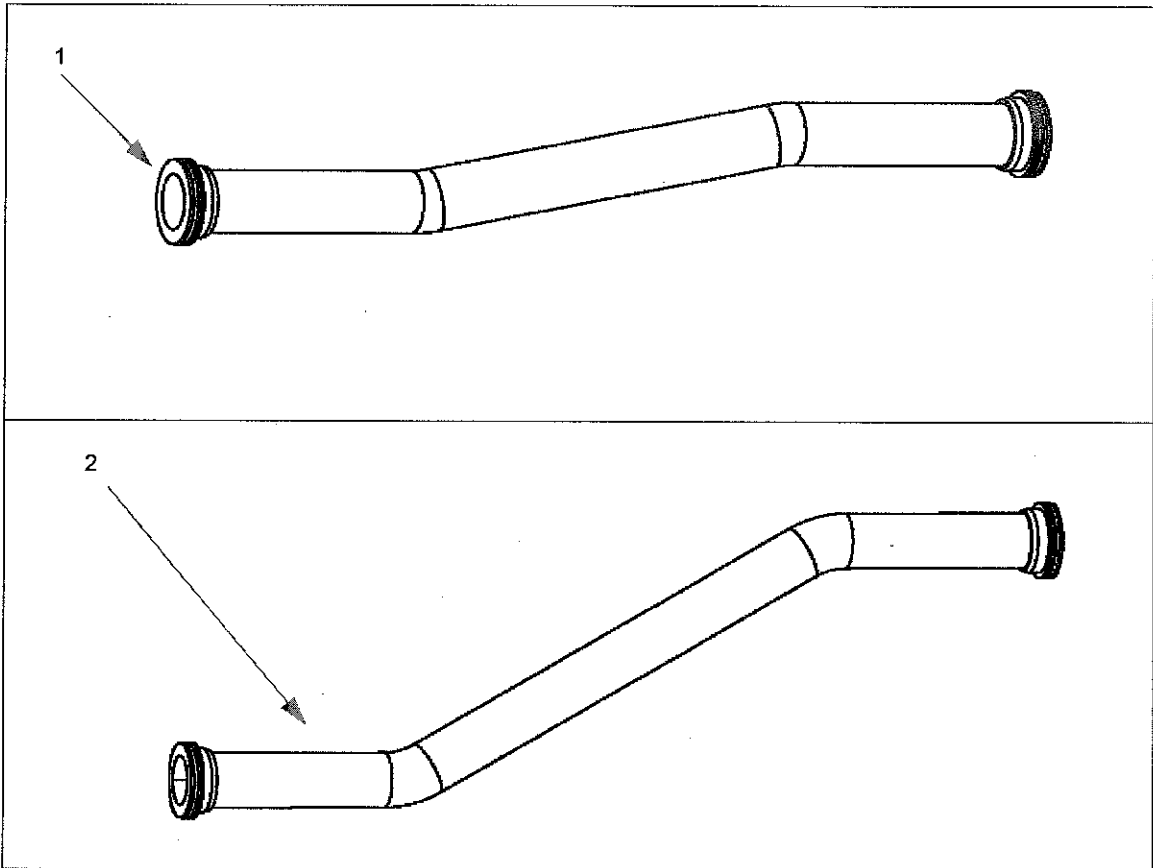

Item #	Description	Current Part	Previous Part	Quantity
1	Discharge Tube Assembly (Grades 1 through 4)	M03520A001	-	1
2	Discharge Tube Assembly (Grade 2 and 3)	M03521A001	-	1
3	• Sleeve, Parflange	N23907-01	-	2
4	• Clamp, Parflange 7/8 in	M00445B001	-	1
5	• O-Ring 0.862 X 0.103 X 0.103	Q12974-118	N16891-32	1
6	• Screw, Metric M8 X 16 (See Note)	-	-	2

Note: Refer to kit K96620-01 (includes screws, nuts, bolts) to replace fasteners.

Self-contained Feedline - Encore 500

Pump Feedline

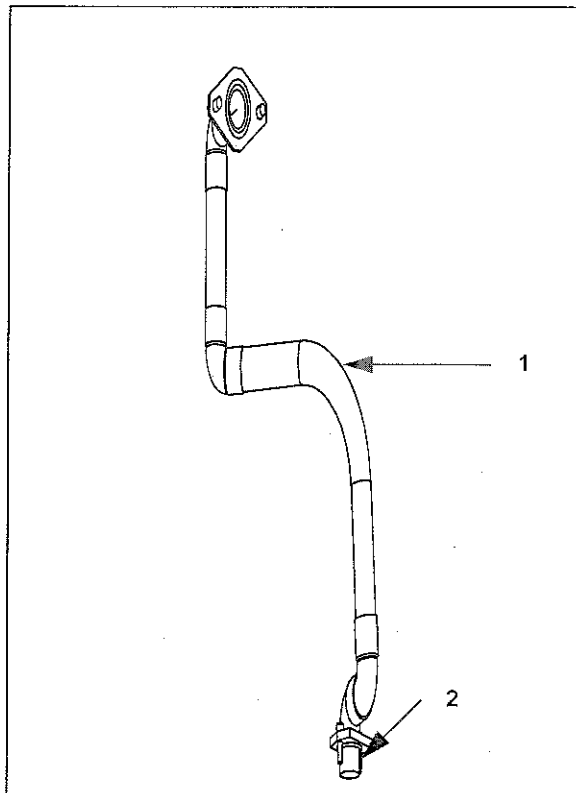

Item #	Description	Current Part	Quantity
1	Assembly, Feedline Tube	M06218A001	1
2	Assembly, Lower Frame Brace	M04868B001	1

Self-contained Feedline - Encore 550 SMART Meter

Pump Feedline

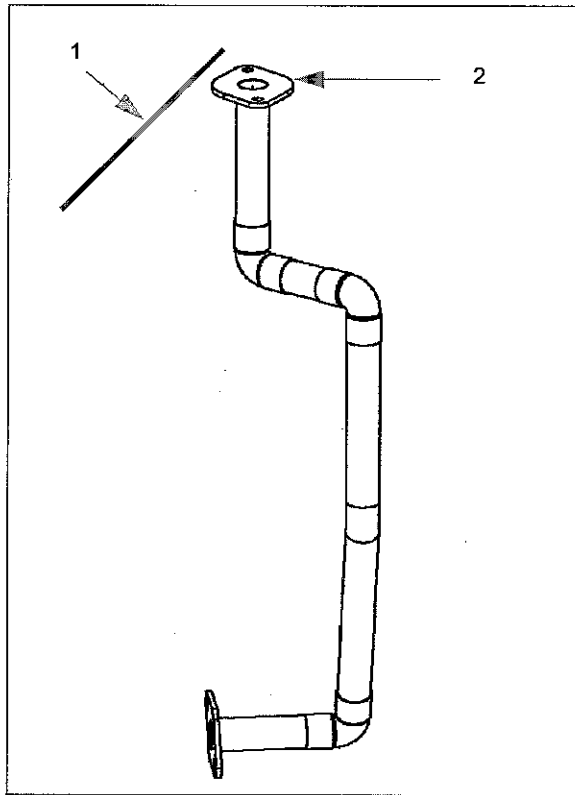

Item #	Description	Current Part	Previous Part	Quantity
1	Self-contained Feedline Tube Assembly	-	M03653A001	1
2	• Manifold Inlet Flange	M03655B001	-	1

Ecometer Discharge Tubing

Item #	Description	Current Part	Quantity
1	Assembly Discharge Tube Front Grade 1 Left	M08786A001	1
2	Assembly Discharge Tube GR2 Front Left	M08787A001	1
3	Assembly Discharge Tube GR1 Rear Right	M08788A001	1
4	Assembly Discharge Tube GR2 Rear Right	M08789A001	1
5	Assembly Discharge Tube Back Grade 3	M07597A001	1
6	Assembly Discharge Tube Back Grade 4	M07598A001	1
7	Assembly Discharge Tube Front Grade 3	M07599A001	1
8	Assembly Discharge Tube Front Grade 4	M07600A001	1

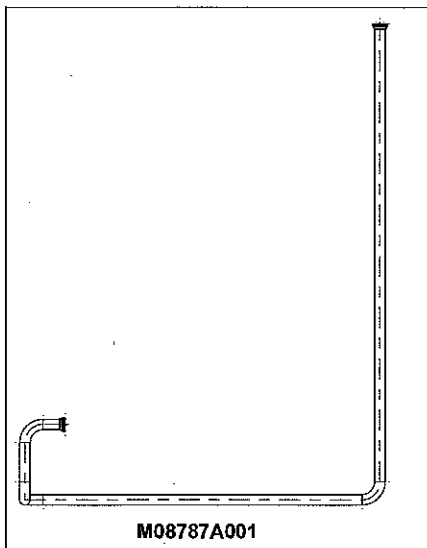
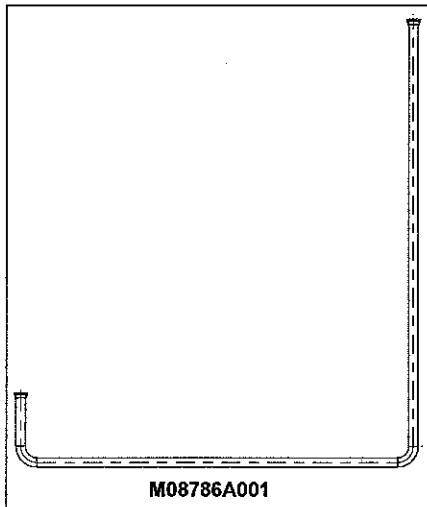

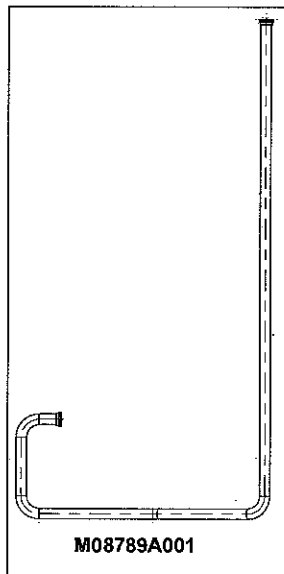
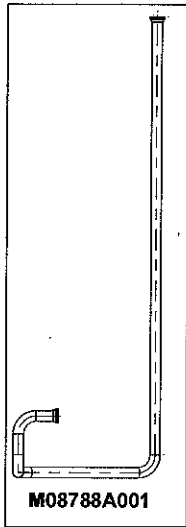

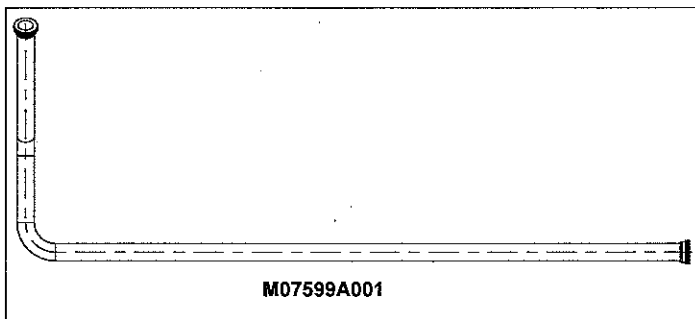
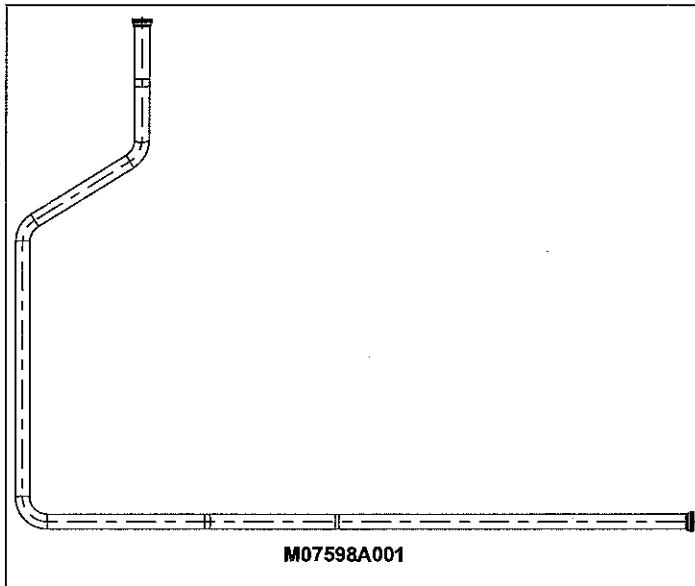

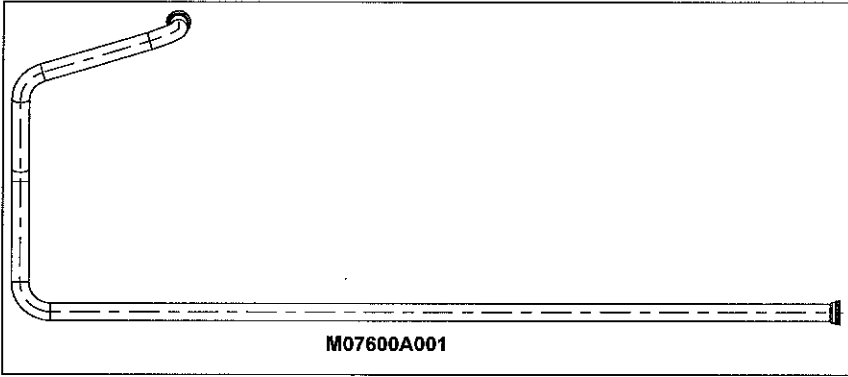

Healy Vapor Tube Assembly

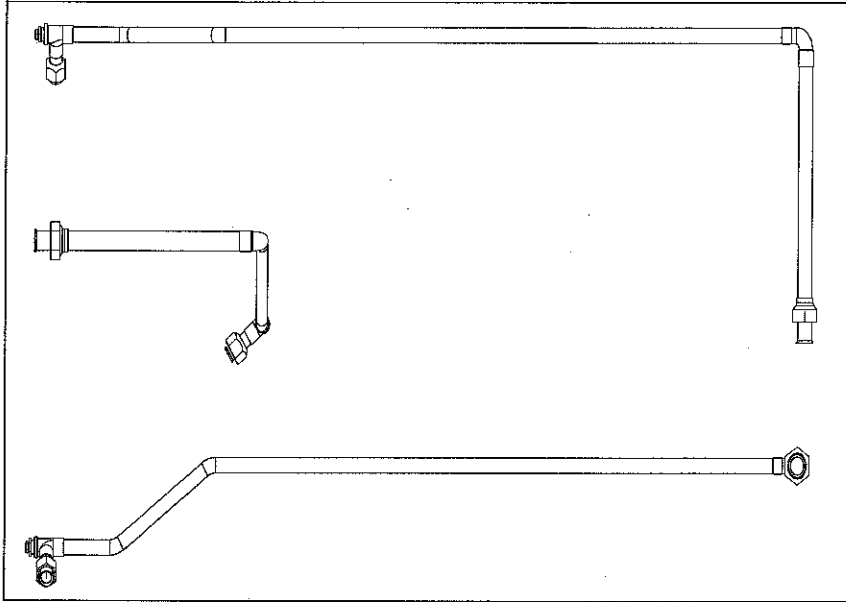

Item #	Description	Current Part	Previous Part	Quantity
1	Healy Vapor Tube Assembly	M06915A002	M06915A001	1

Ecometer Tubing

